

Typical Applications

The HMC216MS8 / HMC216MS8E is ideal for:

- Base Stations
- WirelessLAN
- PCMCIA
- Portable Wireless

Features

Input IP3: +25 dBm @ +11 dBm LO

LO Range = +3 to +11 dBm

Conversion Loss: 8.5 dB

LO / RF Isolation: 32 dB

Functional Diagram

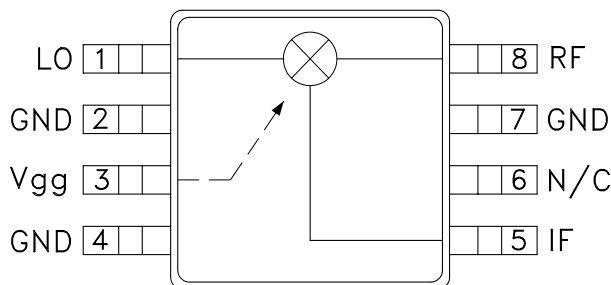

General Description

The HMC216MS8 & HMC216MS8E are ultra miniature double-balanced FET mixers in 8 lead plastic surface mount packages (MSOP). This MMIC mixer is constructed of switched GaAs FETs and novel planar transformer baluns on the chip. In addition to an LO drive of +3 to +13 dBm, a gate voltage of $V_{gg} = -0.9$ to -1.6 Vdc is required. The device can be used as an upconverter or downconverter for 1900 or 2400 MHz applications. The consistent MMIC performance will improve system operation and assure regulatory compliance.

Electrical Specifications, $T_A = +25^\circ\text{C}$, As a Function of LO Drive, $V_{gg} = -1.2\text{Vdc}$

Parameter	LO = +11 dBm			LO = +7 dBm			LO = +3 dBm			Units
	Min.	Typ.	Max.	Min.	Typ.	Max.	Min.	Typ.	Max.	
Frequency Range, RF & LO	1.3 - 2.5			1.6 - 2.3			1.7 - 2.0			GHz
Frequency Range, IF	DC - 0.65			DC - 0.5			DC - 0.4			GHz
Conversion Loss		9	10.5		8.5	10		9	10.5	dB
Noise Figure (SSB)		9	10.5		8.5	10		9	10.5	dB
LO to RF Isolation	27	30		27	32		27	32		dB
LO to IF Isolation	17	20		17	20		17	20		dB
IP3 (Input)	21	25		14	18		8	12		dBm
1 dB Gain Compression (Input)	8	11		5	10		3	8		dBm



**GaAs MMIC SMT DOUBLE-BALANCED
FET MIXER, 1.3 - 2.5 GHz**

**Conversion Loss vs
Temperature @ LO = +7 dBm**

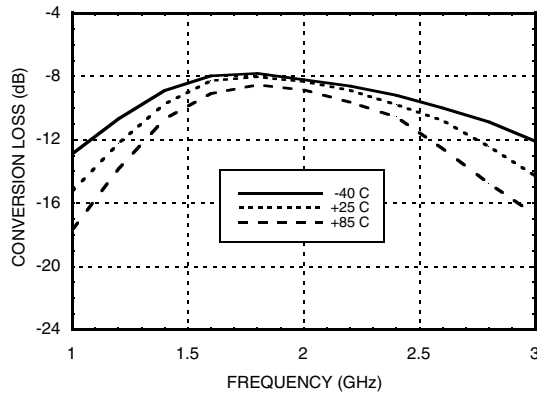

Isolation @ LO = +7 dBm

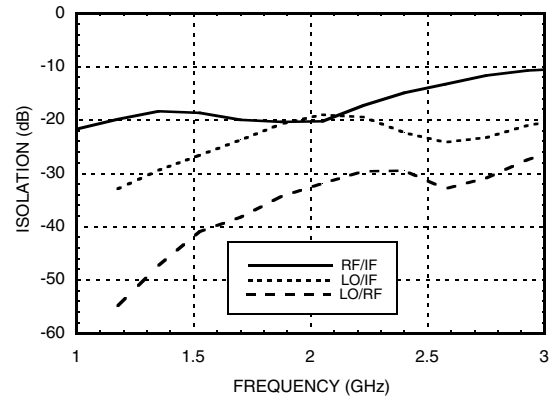

Conversion Loss vs. LO Drive

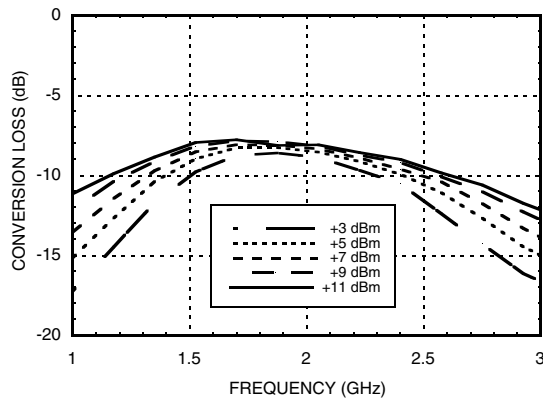

Return Loss @ LO = +7 dBm

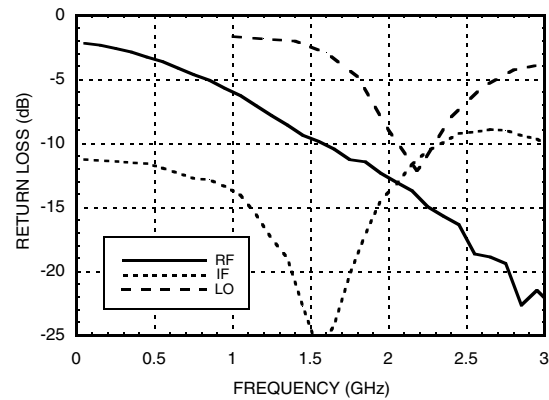

IF Bandwidth @ LO = +7 dBm

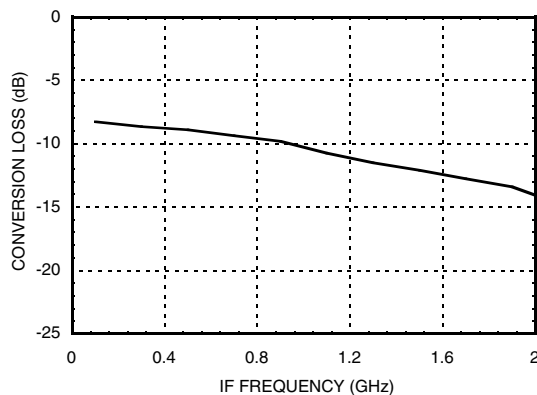

**P1dB vs. Temperature for
LO = +7 dBm, V_{gg} = -1.2 Vdc**

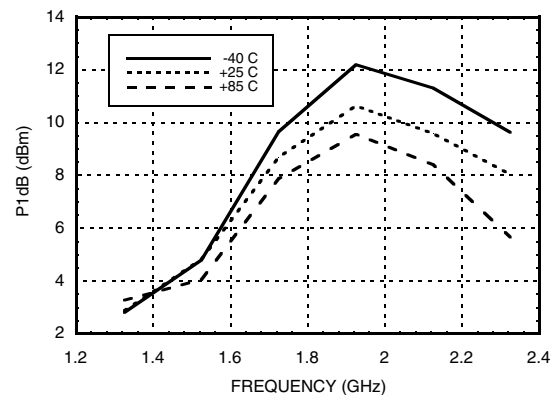

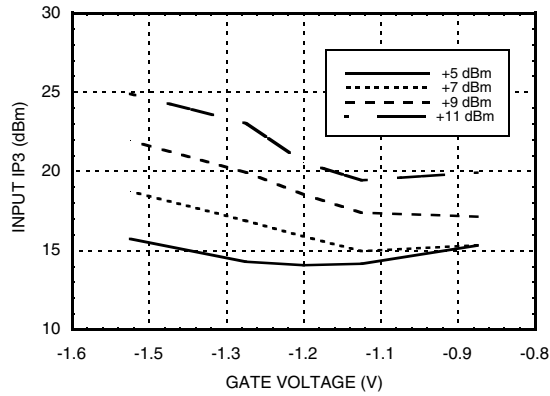
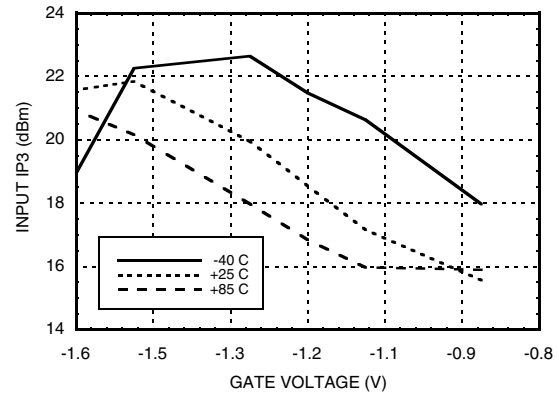
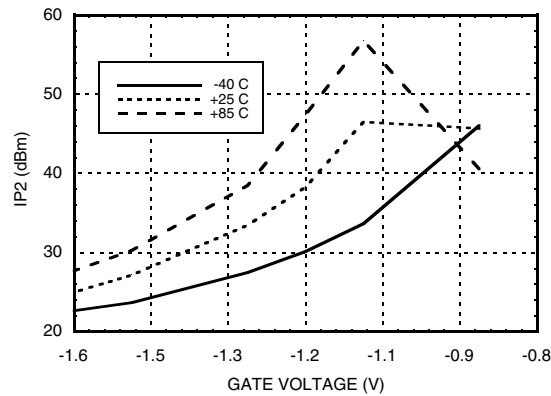
**GaAs MMIC SMT DOUBLE-BALANCED
FET MIXER, 1.3 - 2.5 GHz**
Input IP3 vs. LO Drive and V_{gg}

**Input IP3 vs. Temperature
and V_{gg} for @ LO = +7 dBm**

**Input IP2 vs. Temperature
and V_{gg} for @ LO = +7 dBm**



**GaAs MMIC SMT DOUBLE-BALANCED
FET MIXER, 1.3 - 2.5 GHz**
MxN Spurious Outputs

mRF	nLO				
	0	1	2	3	4
0	xx	-1	14	24	40
1	14	0	28	21	46
2	45	45	59	55	50
3	83	67	62	59	77
4	>105	>105	>105	85	96

RF = 1.975 GHz @ -10 dBm
 LO = 1.8 GHz @ +7 dBm, Vgg = -1.2V
 All values in dBc below IF power level (-1RF + 1LO).

Harmonics of LO

LO Freq. (GHz)	nLO Spur at RF Port			
	1	2	3	4
1.5	41	47	61	78
1.7	38	47	72	71
1.9	34	41	69	72
2.1	31	37	72	79
2.3	29	38	74	74
2.5	32	45	65	74

LO = +7 dBm, Vgg = 1.2V
 Values in dBc below input LO level measured at the RF port.

Absolute Maximum Ratings

RF / IF Input	+13 dBm
LO Drive	+27 dBm
Storage Temperature	-65 to +150 °C
Operating Temperature	-40 to +85 °C



**ELECTROSTATIC SENSITIVE DEVICE
OBSERVE HANDLING PRECAUTIONS**

Outline Drawing

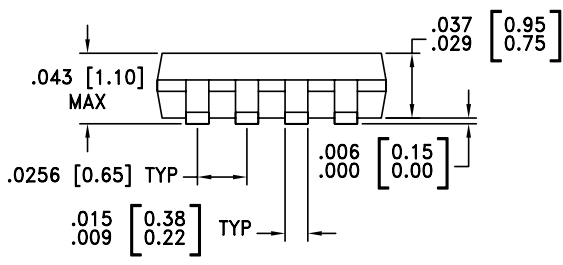
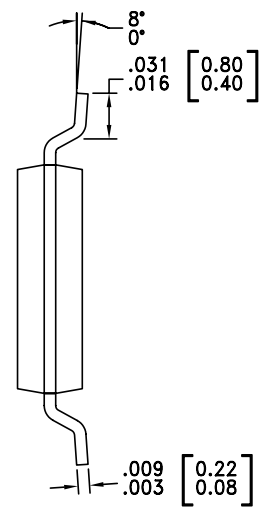
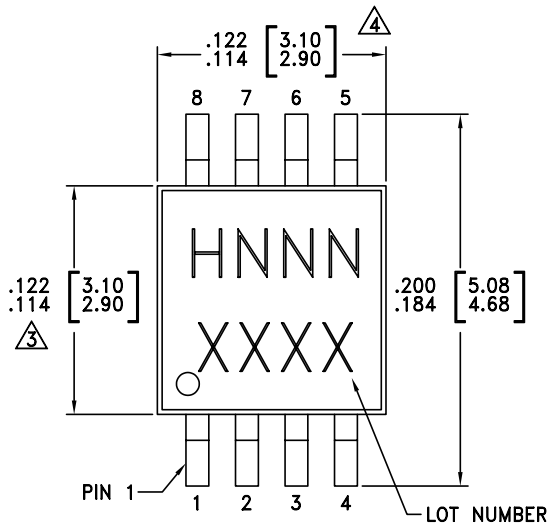

- NOTES:
1. LEADFRAME MATERIAL: COPPER ALLOY
 2. DIMENSIONS ARE IN INCHES [MILLIMETERS]
 3. DIMENSION DOES NOT INCLUDE MOLDFLASH OF 0.15mm PER SIDE.
 4. DIMENSION DOES NOT INCLUDE MOLDFLASH OF 0.25mm PER SIDE.
 5. ALL GROUND LEADS MUST BE SOLDERED TO PCB RF GROUND.

Package Information

Part Number	Package Body Material	Lead Finish	MSL Rating	Package Marking ^[3]
HMC216MS8	Low Stress Injection Molded Plastic	Sn/Pb Solder	MSL1 ^[1]	H216 XXXX
HMC216MS8E	RoHS-compliant Low Stress Injection Molded Plastic	100% matte Sn	MSL1 ^[2]	H216 XXXX

[1] Max peak reflow temperature of 235 °C
 [2] Max peak reflow temperature of 260 °C
 [3] 4-Digit lot number XXXX

MIXERS - SINGLE & DOUBLE-BALANCED - SMT

Evaluation Circuit Board

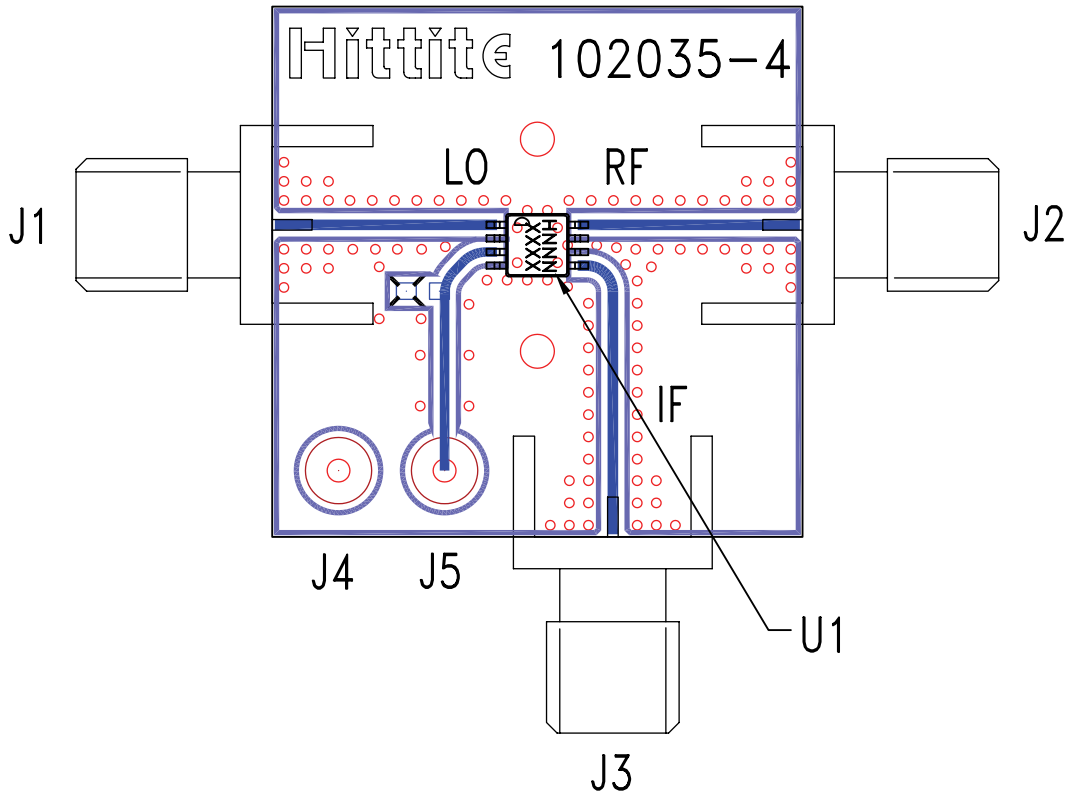

List of Materials for Evaluation PCB 102037 [1]

Item	Description
J1 - J3	PCB Mount SMA RF Connector
J4, J5	DC Pin
U1	HMC216MS8 / HMC216MS8E Mixer
PCB [2]	102035 Evaluation Board

[1] Reference this number when ordering complete evaluation PCB

[2] Circuit Board Material: Rogers 4350

The circuit board used in the application should use RF circuit design techniques. Signal lines should have 50 Ohm impedance while the package ground leads should be connected directly to the ground plane similar to that shown. A sufficient number of via holes should be used to connect the top and bottom ground planes. The evaluation circuit board shown is available from Hittite upon request.