





Grayhill, Inc.

**62S11-L5-040C**

Teilenummer:	62S11-L5-040C
Hersteller / Marke:	Grayhill, Inc.
Produktbeschreibung	ROTARY ENCODER OPTICAL 32PPR
Datenblätter:	 <a href="#">62S11-L5-040C.pdf</a>
RoHS Status	 Bleifrei / RoHS-konform
Zustand des Lagers	1990 pcs stock
Liefern von	Hongkong
Versandweg	DHL/Fedex/TNT/UPS/EMS



**ANGEBOTSANFRAGE**

Bild kann Darstellung sein. Siehe Spezifikationen für Produktdetails.

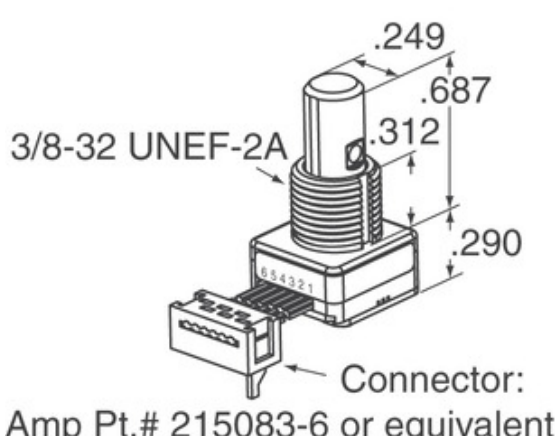

## Spezifikationen von 62S11-L5-040C

TEILENUMMER	62S11-L5-040C
HERSTELLER	Grayhill, Inc.
BESCHREIBUNG	ROTARY ENCODER OPTICAL 32PPR
BLEIFREIER STATUS / ROHS STATUS	Bleifrei / RoHS-konform
VERFÜGBARE MENGE	1990 pcs
DATENBLATT	 <a href="#">62S11-L5-040C.pdf</a>
SPANNUNGSVERSORGUNG	5V
ABSCHLUSSART	Cable with Connector
SERIE	62S
ROTATIONSLEBENSDAUER (ZYKLEN MIN)	1M
IMPULSE PRO UMDREHUNG	32
AUSGABETYP	Quadrature (Incremental)
ANDERE NAMEN	62S11L5040C
ORIENTIERUNG	Vertical
BEFESTIGUNGSART	Panel Mount
FEUCHTIGKEITSEMPFINDLICHKEITSNIVEAU (MSL)	1 (Unlimited)
BLEIFREIER STATUS / ROHS-STATUS	Lead free / RoHS Compliant
ENCODERTYP	Optical
RASTE	Yes
INTEGRIERTER SCHALTER	Yes
BETÄTIGERTYP	1/4" Dia Flatted End

**Verwandte Tags**

Grayhill, Inc. 62S11-L5-040C	62S11-L5-040C-Vertriebspartner	62S11-L5-040C Lieferant
62S11-L5-040C Preis	62S11-L5-040C Bilder	62S11-L5-040C-Bild
62S11-L5-040C PDF-Datenblatt	62S11-L5-040C Datenblatt herunterladen	62S11-L5-040C Datenblatt
62S11-L5-040C-Bestand	62S11-L5-040C kaufen	Grayhill, Inc. kaufen 62S11-L5-040C
Grayhill, Inc. 62S11-L5-040C	Grayhill, Inc. Lieferant	Grayhill, Inc.-Vertriebspartner
Grayhill, Inc. 62S11-L5-040C	Grayhill Inc. 62S11-L5-040C	

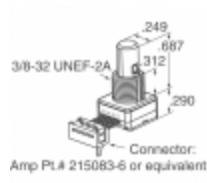
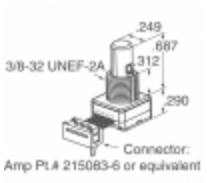
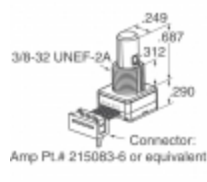
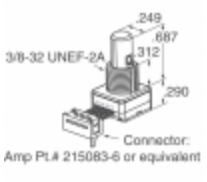
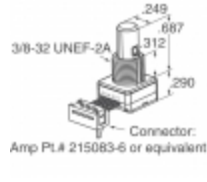
**Verwandte Produkte**

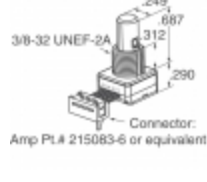
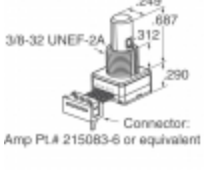
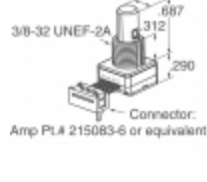
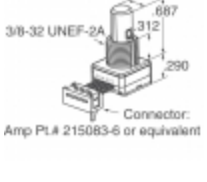
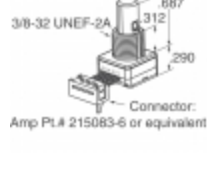
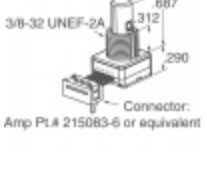
 <p><b>62S11-L5-020C</b>  Hersteller: Grayhill, Inc.  Beschreibung: ROTARY ENCODER OPTICAL 32PPR  Auf Lager: 2095 pcs</p> <p><b>RFQ</b></p>	 <p><b>62S11-L4-PH</b>  Hersteller: Grayhill, Inc.  Beschreibung: ROTARY ENCODER OPTICAL 32PPR  Auf Lager: 2261 pcs</p> <p><b>RFQ</b></p>
 <p><b>62S11-L4-P</b>  Hersteller: Grayhill, Inc.  Beschreibung: ROTARY ENCODER OPTICAL 32PPR  Auf Lager: 2037 pcs</p> <p><b>RFQ</b></p>	 <p><b>62S11-L5-050CH</b>  Hersteller: Grayhill, Inc.  Beschreibung: ROTARY ENCODER OPTICAL 32PPR  Auf Lager: 2186 pcs</p> <p><b>RFQ</b></p>
 <p><b>62S11-L5-060C</b>  Hersteller: Grayhill, Inc.  Beschreibung: ROTARY ENCODER OPTICAL 32PPR  Auf Lager: 2163 pcs</p> <p><b>RFQ</b></p>	 <p><b>62S11-L5-PH</b>  Hersteller: Grayhill, Inc.  Beschreibung: ROTARY ENCODER OPTICAL 32PPR  Auf Lager: 2218 pcs</p> <p><b>RFQ</b></p>
 <p><b>62S11-L5-035C</b>  Hersteller: Grayhill, Inc.  Beschreibung: ROTARY ENCODER OPTICAL 32PPR  Auf Lager: 1861 pcs</p> <p><b>RFQ</b></p>	 <p><b>62S11-L5-020CH</b>  Hersteller: Grayhill, Inc.  Beschreibung: ROTARY ENCODER OPTICAL 32PPR  Auf Lager: 1861 pcs</p> <p><b>RFQ</b></p>
 <p><b>62S11-L9-020C</b>  Hersteller: Grayhill, Inc.  Beschreibung: ROTARY ENCODER OPTICAL 32PPR  Auf Lager: 1773 pcs</p> <p><b>RFQ</b></p>	 <p><b>62S11-L5-030S</b>  Hersteller: Grayhill, Inc.  Beschreibung: ROTARY ENCODER OPTICAL 32PPR  Auf Lager: 2248 pcs</p> <p><b>RFQ</b></p>
 <p><b>62S11-L9-020CH</b>  Hersteller: Grayhill, Inc.  Beschreibung: ROTARY ENCODER OPTICAL 32PPR  Auf Lager: 2264 pcs</p> <p><b>RFQ</b></p>	 <p><b>62S11-L5-P</b>  Hersteller: Grayhill, Inc.  Beschreibung: ROTARY ENCODER OPTICAL 32PPR  Auf Lager: 2265 pcs</p> <p><b>RFQ</b></p>

**Copyright © 2020 Zuverlässiger Distributor von elektronischen Komponenten**
Email: [Info@infinity-electronic.com](mailto:Info@infinity-electronic.com)

Adresse: 17F, Gaylord Geschäftshaus, 114-118 Lockhart Road, Wan Chai, Hongkong

