

**Honeywell**

Honeywell Sensing and

**78628-B0000010-01**

Teilenummer:	78628-B0000010-01
Hersteller / Marke:	Honeywell Sensing and Productivity Solutions
Produktbeschreibung	SWITCH PRESSURE N.O. 1PSI <a href="#">1.78628-B0000010-01.pdf</a> <a href="#">2.78628-B0000010-01.pdf</a> <a href="#">3.78628-B0000010-01.pdf</a> <a href="#">4.78628-B0000010-01.pdf</a>
Datenblätter:	
RoHS Status	 Bleifrei / RoHS-konform
Zustand des Lagers	2292 pcs stock
Liefern von	Hongkong
Versandweg	DHL/Fedex/TNT/UPS/EMS

**ANGEBOTSANFRAGE**

Bild kann Darstellung sein. Siehe Spezifikationen für Produktdetails.







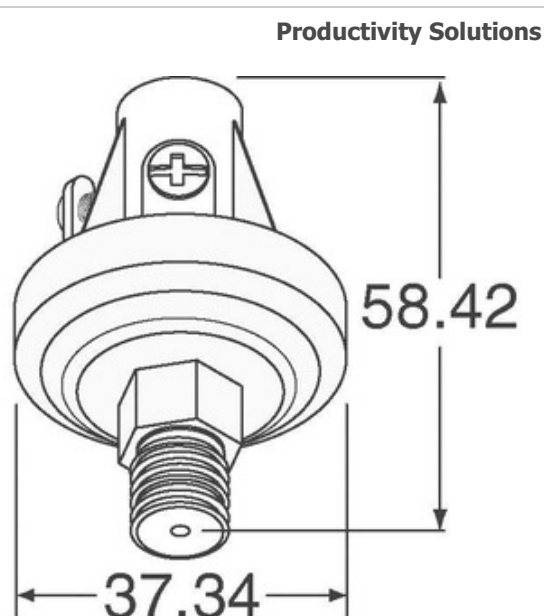





## Spezifikationen von 78628-B0000010-01

TEILENUMMER	78628-B0000010-01
HERSTELLER	Honeywell Sensing and Productivity Solutions
BESCHREIBUNG	SWITCH PRESSURE N.O. 1PSI
BLEIFREIER STATUS / ROHS STATUS	Bleifrei / RoHS-konform
VERFÜGBARE MENGE	2292 pcs
DATENBLATT	<a href="#">1.78628-B0000010-01.pdf</a> <a href="#">2.78628-B0000010-01.pdf</a> <a href="#">3.78628-B0000010-01.pdf</a> <a href="#">4.78628-B0000010-01.pdf</a>
SPANNUNGSVERSORGUNG	-
ABSCHLUSSART	Screw
SUPPLIER DEVICE-GEHÄUSE	-
SERIE	5000
DRUCK-ART	Switch
PORT-STIL	Threaded
ANSCHLUSSGRÖSSE	Male - 1/8" (3.18mm) NPT
VERPACKUNG / GEHÄUSE	Cylinder, Threaded
AUSGABETYP	SPST-NO
AUSGABE	-
ANDERE NAMEN	480-6838 7628 1 N/O
BETRIEBSTEMPERATUR	-40°C ~ 250°C
BETRIEBSDRUCK	1 PSI (6.89 kPa)
FEUCHTIGKEITSEMPFINDLICHKEITSNIVEAU (MSL)	1 (Unlimited)
MAXIMALER DRUCK	500 PSI (3447.38 kPa)
BLEIFREIER STATUS / ROHS-STATUS	Lead free / RoHS Compliant
EIGENSCHAFTEN	-
DETAILLIERTE BESCHREIBUNG	Pressure Sensor 1 PSI (6.89 kPa) Switch Male - 1/8" (3.18mm) NPT Cylinder, Threaded
GENAUIGKEIT	-

**Verwandte Tags**

Honeywell Sensing and Productivity Solutions 78628-B0000010-01	78628-B0000010-01-Vertriebspartner	78628-B0000010-01 Lieferant
78628-B0000010-01 Preis	78628-B0000010-01 Bilder	78628-B0000010-01-Bild
78628-B0000010-01 PDF-Datenblatt	78628-B0000010-01 Datenblatt herunterladen	78628-B0000010-01 Datenblatt
78628-B0000010-01-Bestand	78628-B0000010-01 kaufen	Honeywell Sensing and Productivity Solutions kaufen 78628-B0000010-01
Honeywell Sensing and Productivity Solutions 78628-B0000010-01	Honeywell Sensing and Productivity Solutions Lieferant	Honeywell Sensing and Productivity Solutions-Vertriebspartner
Honeywell Sensing and Productivity Solutions 78628-B0000010-01	HONEYWELL 78628-B0000010-01	Honeywell Sensing and Control EMEA 78628-B0000010-01
Honeywell Sensing and Productivity Solutions T&M 78628-B0000010-01		

**Verwandte Produkte**

 <p><b>78624</b>  Hersteller: Wiha  Beschreibung: HSS 1/4" DRIVE 90 COUNTERSINK 20  Auf Lager: 3402 pcs</p> <p><b>RFQ</b></p>	 <p><b>786473-4</b>  Hersteller: Agastat Relays / TE Connectivity  Beschreibung: CONN TERM BLOCK 4POS VERT BRDMNT  Auf Lager: 2725 pcs</p> <p><b>RFQ</b></p>
 <p><b>78628-002</b>  Hersteller: Amphenol FCI  Beschreibung: HPC END MOUNTED GUIDE PIN  Auf Lager: 28940 pcs</p> <p><b>RFQ</b></p>	 <p><b>78621</b>  Hersteller: Wiha  Beschreibung: HSS 1/4" DRIVE 90 COUNTERSINK 12  Auf Lager: 4171 pcs</p> <p><b>RFQ</b></p>
 <p><b>786382-1</b>  Hersteller: Agastat Relays / TE Connectivity  Beschreibung: CONN D-SUB HD RCPT 15P VERT SLDR  Auf Lager: 2991 pcs</p> <p><b>RFQ</b></p>	 <p><b>786356-1</b>  Hersteller: Agastat Relays / TE Connectivity  Beschreibung: CONN D-SUB HD RCPT 15P VERT SLDR  Auf Lager: 6080 pcs</p> <p><b>RFQ</b></p>
 <p><b>7864-0006PR</b>  Hersteller: 3M  Beschreibung: 64/PCB/2ROW/3.8MM  Auf Lager: 4087 pcs</p> <p><b>RFQ</b></p>	 <p><b>78628-0000010-01</b>  Hersteller: Honeywell Sensing and Productivity Solutions  Beschreibung: SWITCH PRESSURE N.O. 1PSI  Auf Lager: 2530 pcs</p> <p><b>RFQ</b></p>
 <p><b>78622</b>  Hersteller: Wiha  Beschreibung: HSS 1/4" DRIVE 90 COUNTERSINK 16  Auf Lager: 3349 pcs</p> <p><b>RFQ</b></p>	 <p><b>7864-0000PR</b>  Hersteller: 3M  Beschreibung: 64/PCB/2ROW/2.8MM  Auf Lager: 15576 pcs</p> <p><b>RFQ</b></p>
 <p><b>786200-1</b>  Hersteller: Agastat Relays / TE Connectivity  Beschreibung: 50SR STKD RA RCPT ASSY,K,SL LN  Auf Lager: 1633 pcs</p> <p><b>RFQ</b></p>	 <p><b>7864-0000T</b>  Hersteller: 3M  Beschreibung: CONN PCB 64POS .100 DL 2.8MM  Auf Lager: 3279 pcs</p> <p><b>RFQ</b></p>