





Grayhill, Inc.

**62S11-N5-P**

Teilenummer:	62S11-N5-P
Hersteller / Marke:	Grayhill, Inc.
Produktbeschreibung	ROTARY ENCODER OPTICAL 32PPR
Datenblätter:	 62S11-N5-P.pdf
RoHS Status	 Bleifrei / RoHS-konform
Zustand des Lagers	1885 pcs stock
Lieferrn von	Hongkong
Versandweg	DHL/Fedex/TNT/UPS/EMS



**ANGEBOTSANFRAGE**

Bild kann Darstellung sein. Siehe Spezifikationen für Produktdetails.





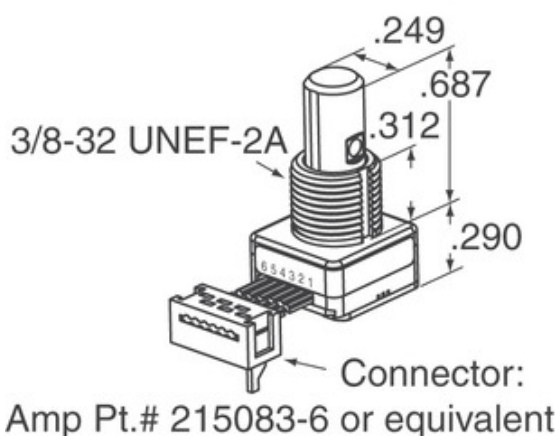

## Spezifikationen von 62S11-N5-P

TEILENUMMER	62S11-N5-P
HERSTELLER	Grayhill, Inc.
BESCHREIBUNG	ROTARY ENCODER OPTICAL 32PPR
BLEIFREIER STATUS / ROHS STATUS	Bleifrei / RoHS-konform
VERFÜGBARE MENGE	1885 pcs
DATENBLATT	 62S11-N5-P.pdf
SPANNUNGSVERSORGUNG	5V
ABSCHLUSSART	PC Pin
SERIE	62S
ROTATIONSLEBENSDAUER (ZYKLEN MIN)	1M
IMPULSE PRO UMDREHUNG	32
AUSGABETYP	Quadrature (Incremental)
ANDERE NAMEN	62S11N5P
ORIENTIERUNG	Vertical
BEFESTIGUNGSART	PCB, Through Hole
FEUCHTIGKEITSEMPFINDLICHKEITSNIVEAU (MSL)	1 (Unlimited)
BLEIFREIER STATUS / ROHS-STATUS	Lead free / RoHS Compliant
ENCODERTYP	Optical
RASTE	No
INTEGRIERTER SCHALTER	Yes
BETÄTIGERTYP	1/4" Dia Flatted End

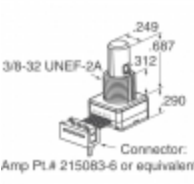
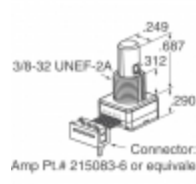
### Verwandte Tags

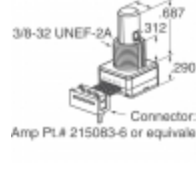
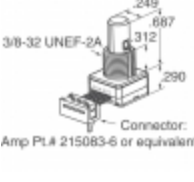
Grayhill, Inc. 62S11-N5-P	62S11-N5-P-Vertriebspartner	62S11-N5-P Lieferant
62S11-N5-P Preis	62S11-N5-P Bilder	62S11-N5-P-Bild
62S11-N5-P PDF-Datenblatt	62S11-N5-P Datenblatt herunterladen	62S11-N5-P Datenblatt
62S11-N5-P-Bestand	62S11-N5-P kaufen	Grayhill, Inc. kaufen 62S11-N5-P
Grayhill, Inc. 62S11-N5-P	Grayhill, Inc. Lieferant	Grayhill, Inc.-Vertriebspartner
Grayhill, Inc. 62S11-N5-P	Grayhill Inc. 62S11-N5-P	

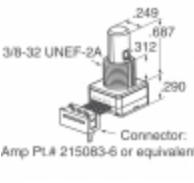
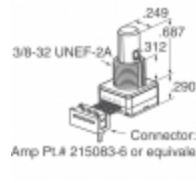
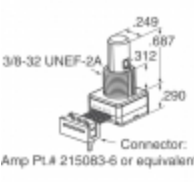
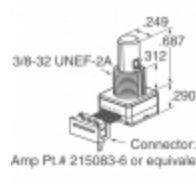
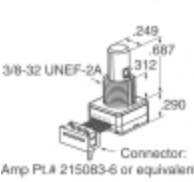
### Verwandte Produkte

 <p><b>62S11-N5-050C</b>  Hersteller: Grayhill, Inc.  Beschreibung: ROTARY ENCODER OPTICAL 32PPR  Auf Lager: 1936 pcs</p> <p><b>RFQ</b></p>	 <p><b>62S11-N9-060SH</b>  Hersteller: Grayhill, Inc.  Beschreibung: ROTARY ENCODER OPTICAL 32PPR  Auf Lager: 1801 pcs</p> <p><b>RFQ</b></p>
 <p><b>62S15-H0-020C</b>  Hersteller: Grayhill, Inc.  Beschreibung: ROTARY ENCODER OPTICAL 24PPR  Auf Lager: 2286 pcs</p> <p><b>RFQ</b></p>	 <p><b>62S11-N5-080SH</b>  Hersteller: Grayhill, Inc.  Beschreibung: ROTARY ENCODER OPTICAL 32PPR  Auf Lager: 1942 pcs</p> <p><b>RFQ</b></p>
 <p><b>62S11-N9-PH</b>  Hersteller: Grayhill, Inc.  Beschreibung: ROTARY ENCODER OPTICAL 32PPR  Auf Lager: 2219 pcs</p> <p><b>RFQ</b></p>	 <p><b>62S11-N9-060C</b>  Hersteller: Grayhill, Inc.  Beschreibung: ROTARY ENCODER OPTICAL 32PPR  Auf Lager: 2192 pcs</p> <p><b>RFQ</b></p>
 <p><b>62S11-N5-120S</b>  Hersteller: Grayhill, Inc.  Beschreibung: ROTARY ENCODER OPTICAL 32PPR  Auf Lager: 1675 pcs</p> <p><b>RFQ</b></p>	 <p><b>62S11-N5-060C</b>  Hersteller: Grayhill, Inc.  Beschreibung: ROTARY ENCODER OPTICAL 32PPR  Auf Lager: 2164 pcs</p> <p><b>RFQ</b></p>
 <p><b>62S11-N5-100C</b>  Hersteller: Grayhill, Inc.  Beschreibung: ROTARY ENCODER OPTICAL 32PPR  Auf Lager: 1789 pcs</p> <p><b>RFQ</b></p>	 <p><b>62S11-N5-060SH</b>  Hersteller: Grayhill, Inc.  Beschreibung: ROTARY ENCODER OPTICAL 32PPR  Auf Lager: 2263 pcs</p> <p><b>RFQ</b></p>
 <p><b>62S11-N9-120S</b>  Hersteller: Grayhill, Inc.  Beschreibung: ROTARY ENCODER OPTICAL 32PPR  Auf Lager: 1784 pcs</p> <p><b>RFQ</b></p>	 <p><b>62S11-N5-PV</b>  Hersteller: Grayhill, Inc.  Beschreibung: ROTARY ENCODER OPTICAL 32PPR  Auf Lager: 2220 pcs</p> <p><b>RFQ</b></p>

Copyright © 2020 Zuverlässiger Distributor von elektronischen Komponenten

Email: Info@infinity-electronic.com

Adresse: 17F, Gaylord Geschäftshaus, 114-118 Lockhart Road, Wan Chai, Hongkong

