



SPECIFICATION

PATENT PENDING

Part No: **FXUB63.07.0150C**

Product Name: LTE Wide Band Flex Antenna 698MHz -3000 MHz

Features: Patent Pending

Ground Plane Independent

698-3000 MHz

>45% Efficiency on All bands

5 dBi Peak Gain

96*21*0.2 mm size

IPEX MHFI (U.FL Compatible)

RoHS Compliant



1. INTRODUCTION

The patent pending FXUB63 flexible ultra wideband antenna has been designed to cover all working frequencies in the 698-3000 MHz spectrum, covering all Cellular, 2.4GHz Wi-Fi, ISM and AGPS. The antenna is delivered with a flexible body with excellent efficiencies on all bands, ground independent, with cable and connector for easy installation.

The FXUB63 flexible polymer antenna, at 96*21*0.2mm, is ultra thin and truly ultra wideband with high efficiencies across the bands. It is assembled by a simple “peel and stick” process, attaching securely to non-metal surfaces via 3M adhesive. It enables designers to use only one antenna that covers all common LTE frequencies.

The FXUB63 antenna is a durable flexible polymer antenna that has a peak gain of 5dBi, an efficiency of more than 45% across the bands and is designed to be mounted directly onto a plastic or glass cover. It is an ideal choice for any device maker that needs to keep manufacturing costs down over the lifetime of a product. It is ground plane independent and delivered with a cable and connector for easy connecting to the wireless module or customer PCB.

Cables and Connectors are customizable. Like all such antennas, care should be taken to mount the antenna at least 10mm from metal components or surfaces, and ideally 20mm for best Radiation efficiency.

2. SPECIFICATION

Band	700/850/900	1575	1700/1800/1900	2100	2400	2600
Standard	CELL	GPS	CELL	CELL	ISM	CELL
Frequency (MHz)	698-960	1575.42	1710-1990	1755-2170	2400-2500	2500-2690
Max VSWR	2:1	2:1	1.8:1	1.7:1	1.7:1	2.3:1
Max Return Loss (dB)	-10	-10	-11	-12	-12	-8
Peak Gain (dBi)	1	2.5	3.5	5	5	4.5
Efficiency (%)	50	75	78	65	75	75
Average Gain (dB)	-3	-2	-2	-2.5	-2	-2
Radiation Properties	Omni-directional					
Max Input Power (Watts)	5					
Polarization	Linear					
Impedance (Ohms)	50 Ohms					

*Antenna measured on plastic plate of 3 mm thickness.

MECHANICAL	
Dimensions (mm)	96*21*0.2 mm
Material	Flexible Polymer
Connector and Cable	U.FL and 1.37 mm mini coax
Cable Length	150 mm

ENVIRONMENTAL	
Operation Temperature	-40°C to 85°C
Storage Temperature	-40°C to 85°C
Relative Humidity	40% to 95%
RoHs Compliant	Yes



3. ANTENNA PARAMETERS

3.1. Return Loss

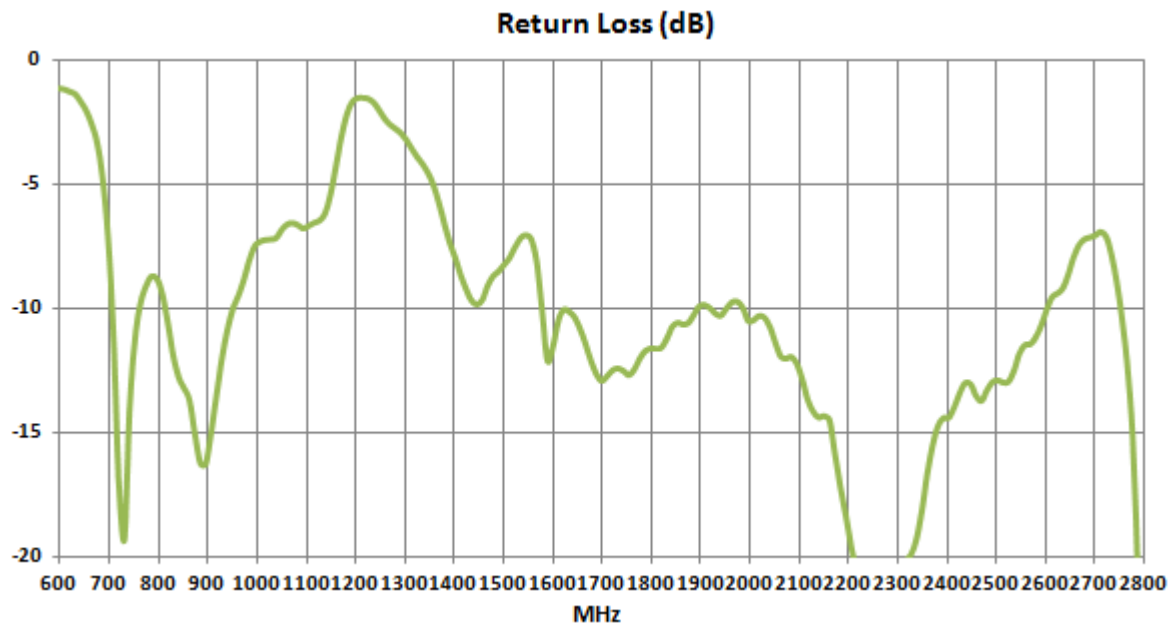

Figure 1. Return loss of FXUB63 Antenna.

3.2. VSWR

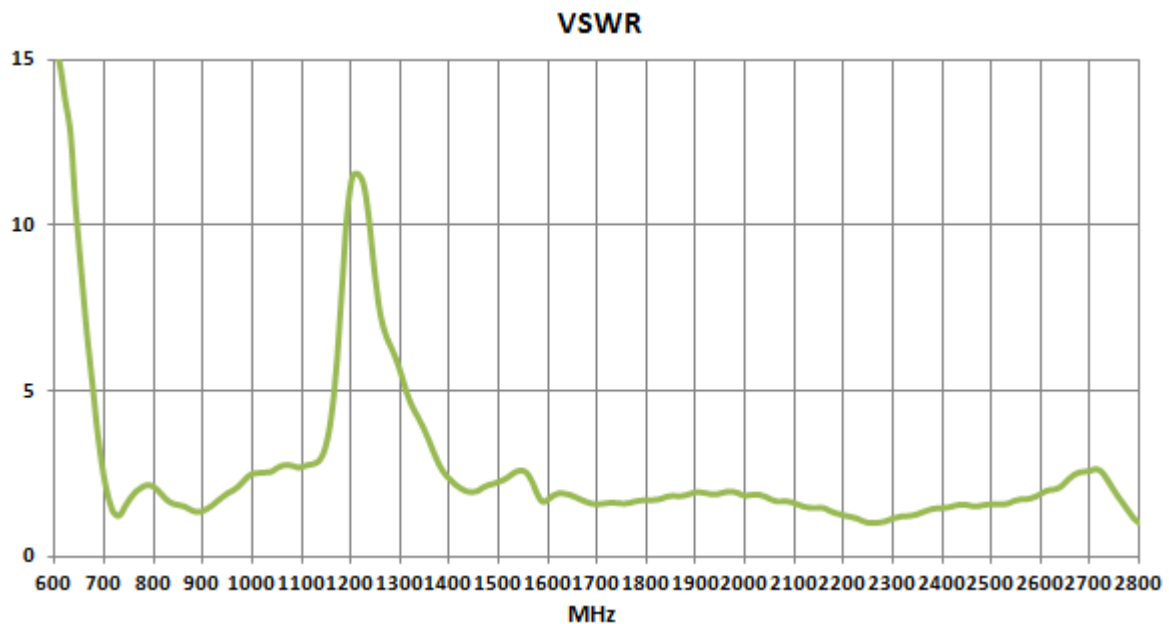

Figure 2. VSWR of FXUB63 Antenna.



3.3. Peak Gain

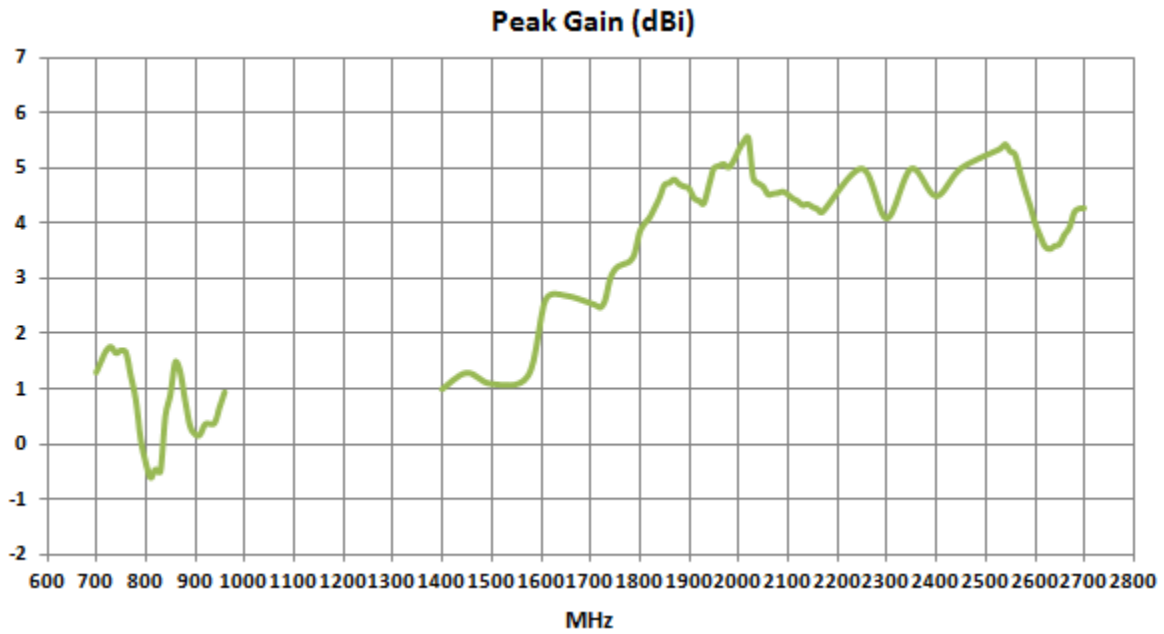

Figure 3. Peak Gain of FXUB63 Antenna.

3.4. Efficiency

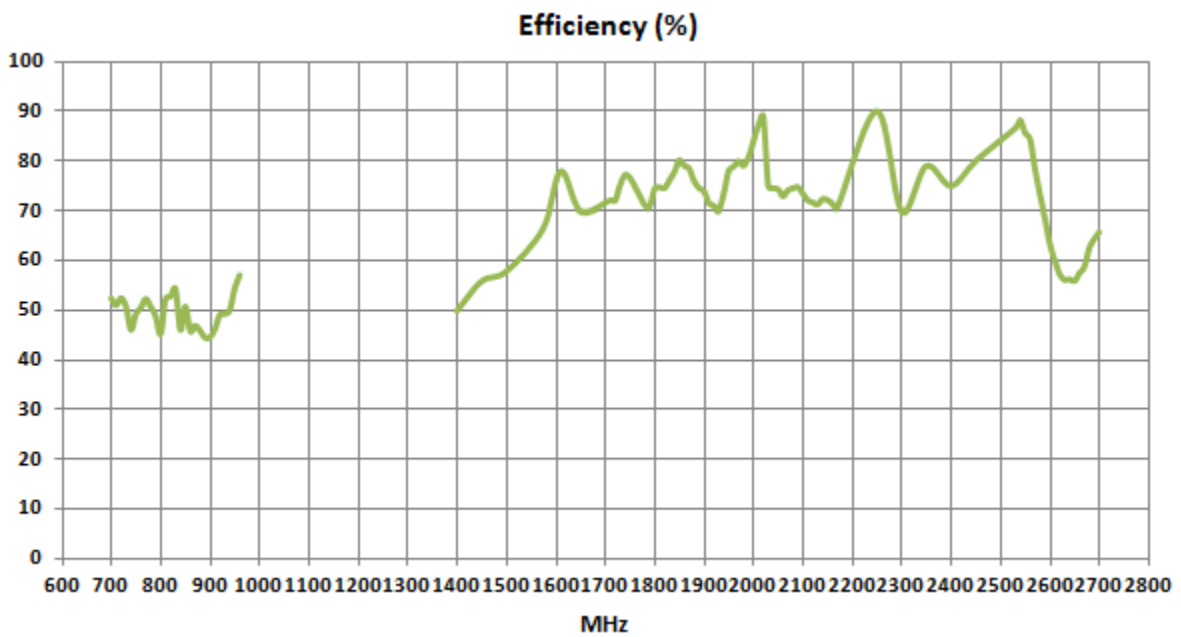

Figure 4. Efficiency of FXUB63 Antenna.

3.5. Average Gain

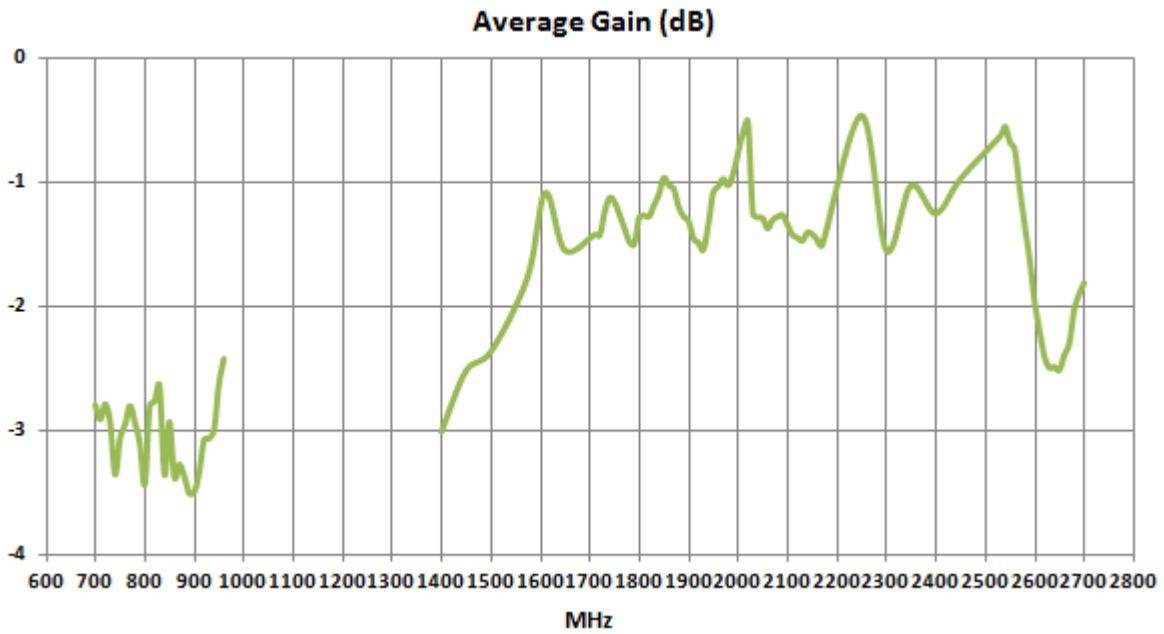

Figure 5. Average Gain of FXUB63 Antenna.

3.6. Radiation Pattern

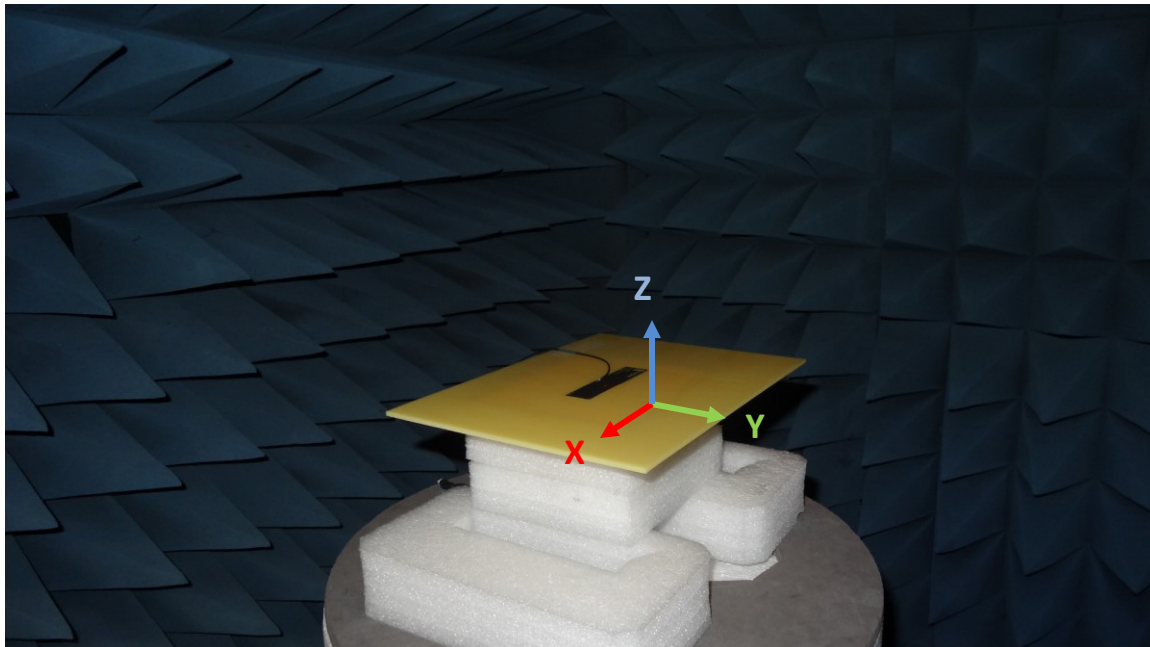

Figure 6. Radiation Pattern Reference of FXUB63 Antenna.

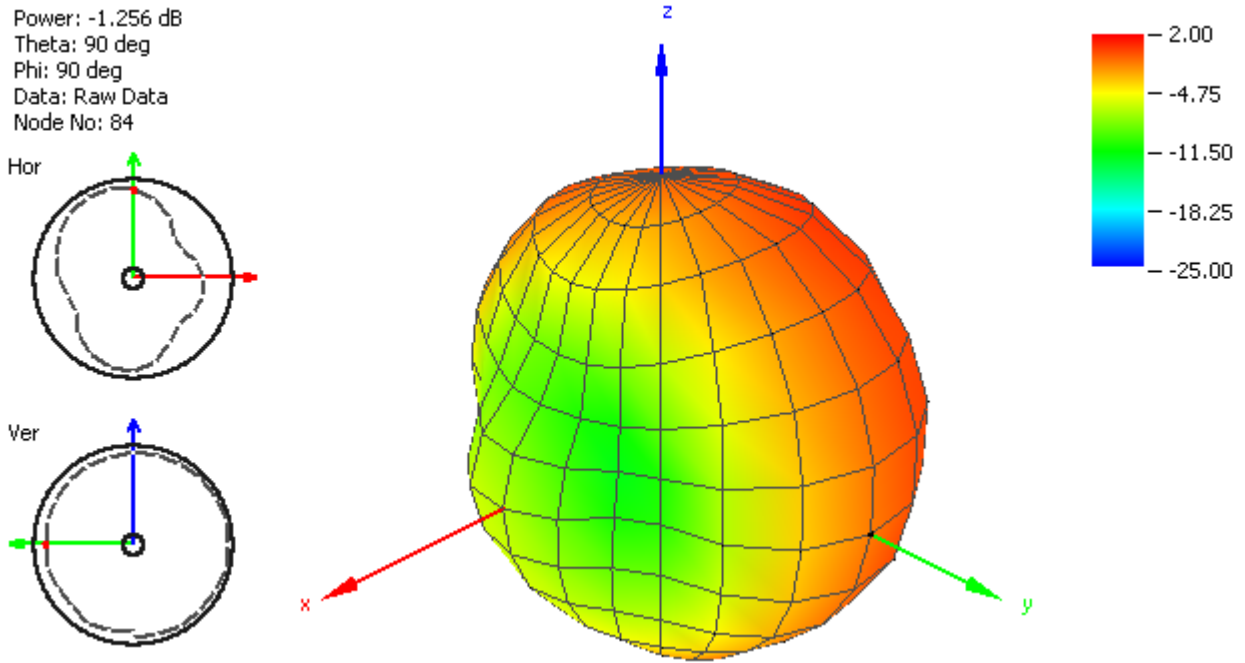

Figure 7. Radiation Pattern at 750 MHz of FXUB63 Antenna.

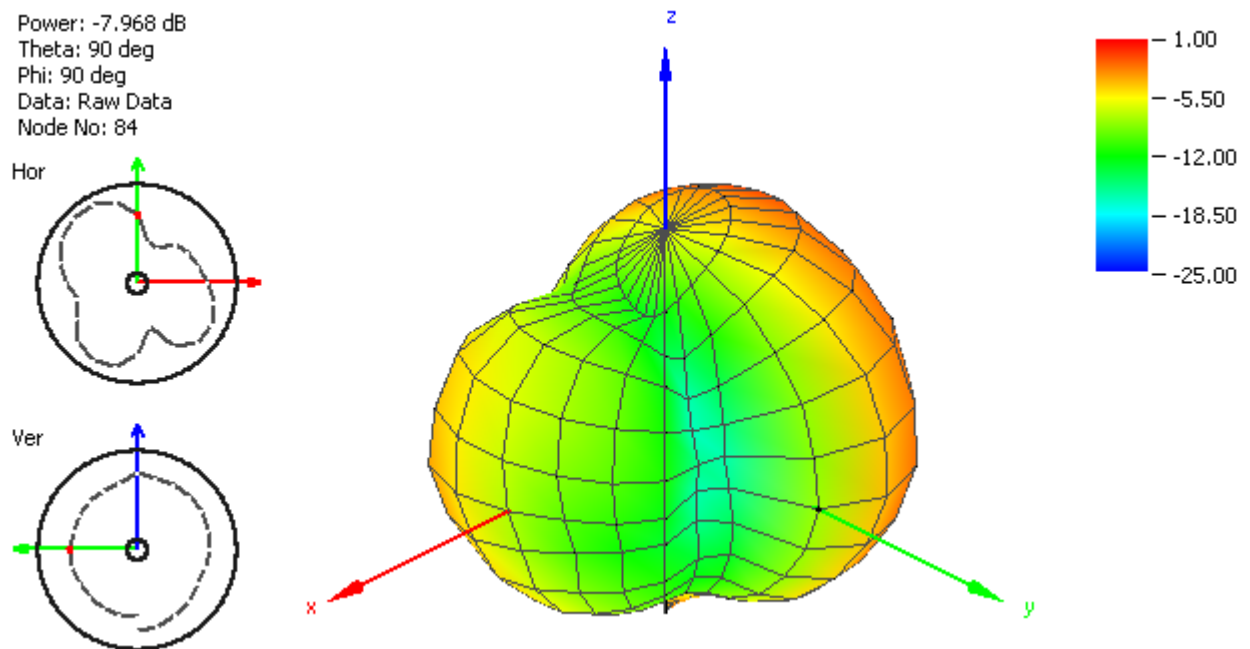

Figure 8. Radiation Pattern at 850 MHz of FXUB63 Antenna.



Power: -8.973 dB
Theta: 90 deg
Phi: 90 deg
Data: Raw Data
Node No: 84

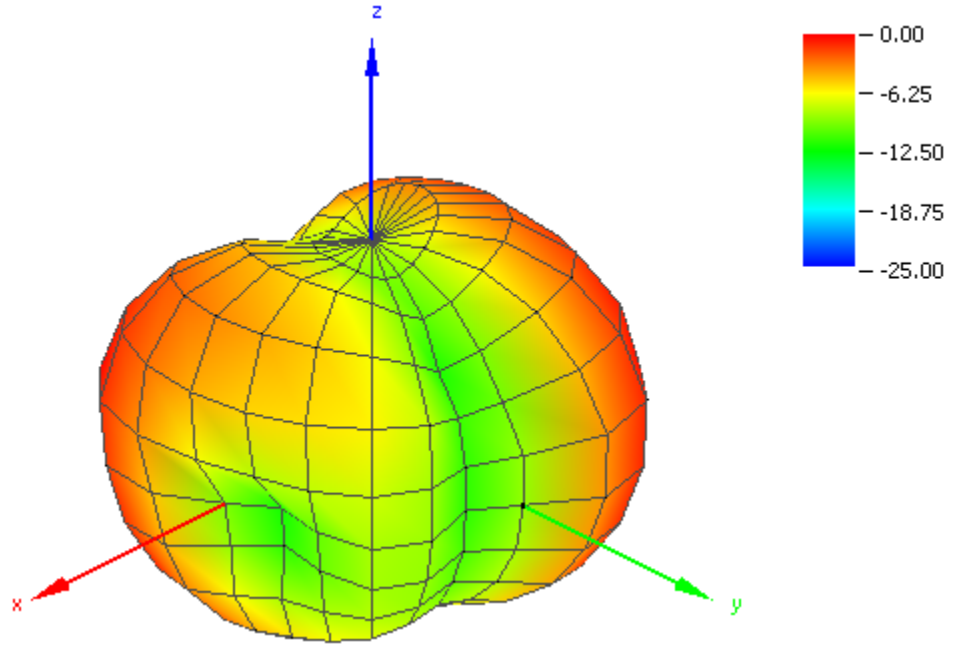
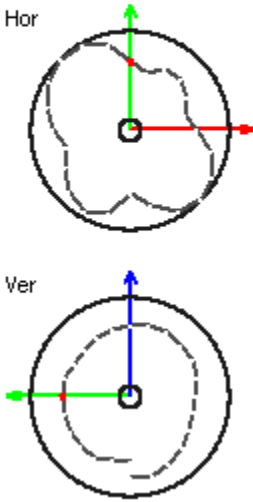

Figure 9. Radiation Pattern at 925 MHz of FXUB63 Antenna.

Power: -0.614 dB
Theta: 90 deg
Phi: 90 deg
Data: Raw Data
Node No: 84

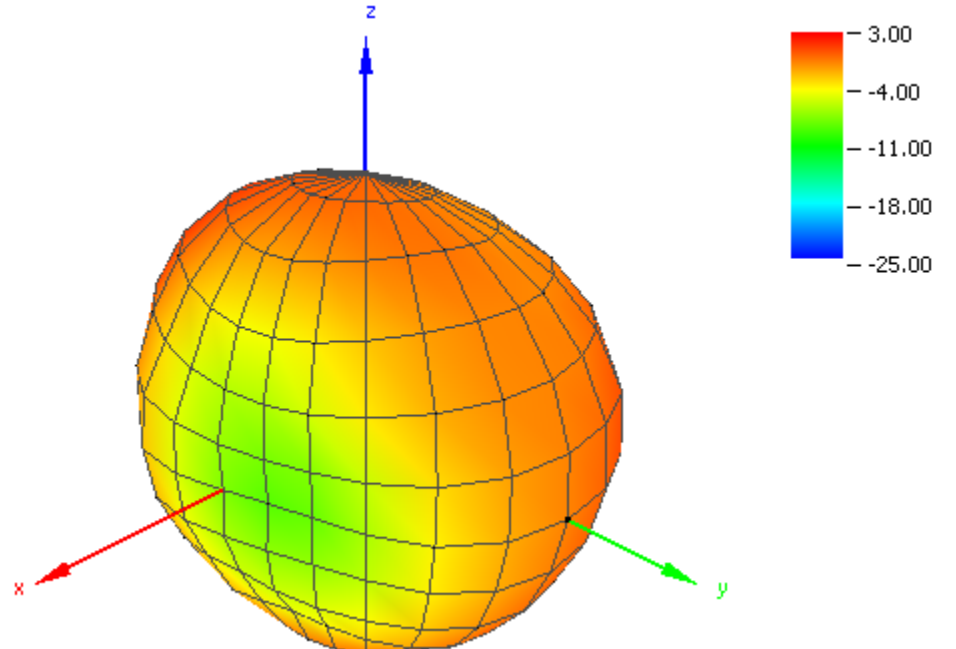
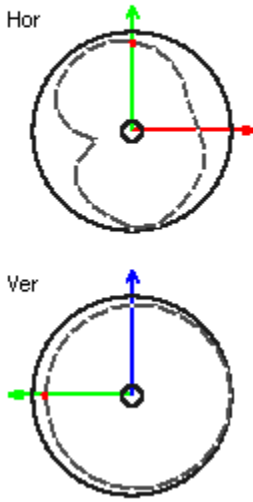

Figure 10. Radiation Pattern at 1400 MHz of FXUB63 Antenna.

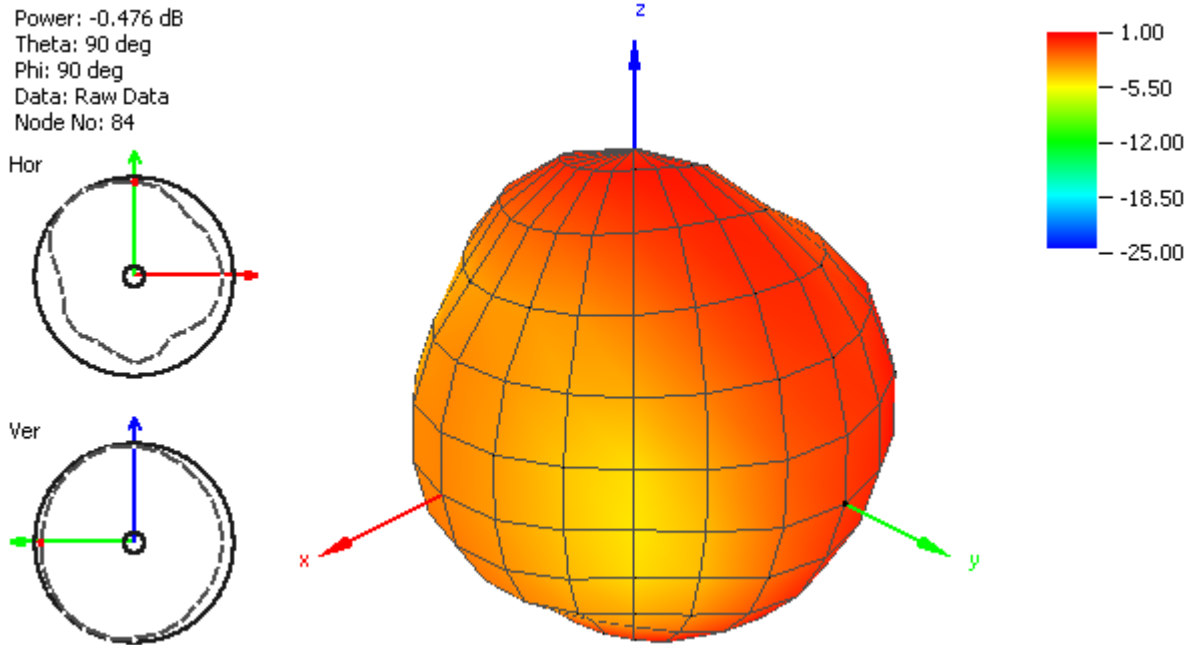

Figure 11. Radiation Pattern at 1575 MHz of FXUB63 Antenna.

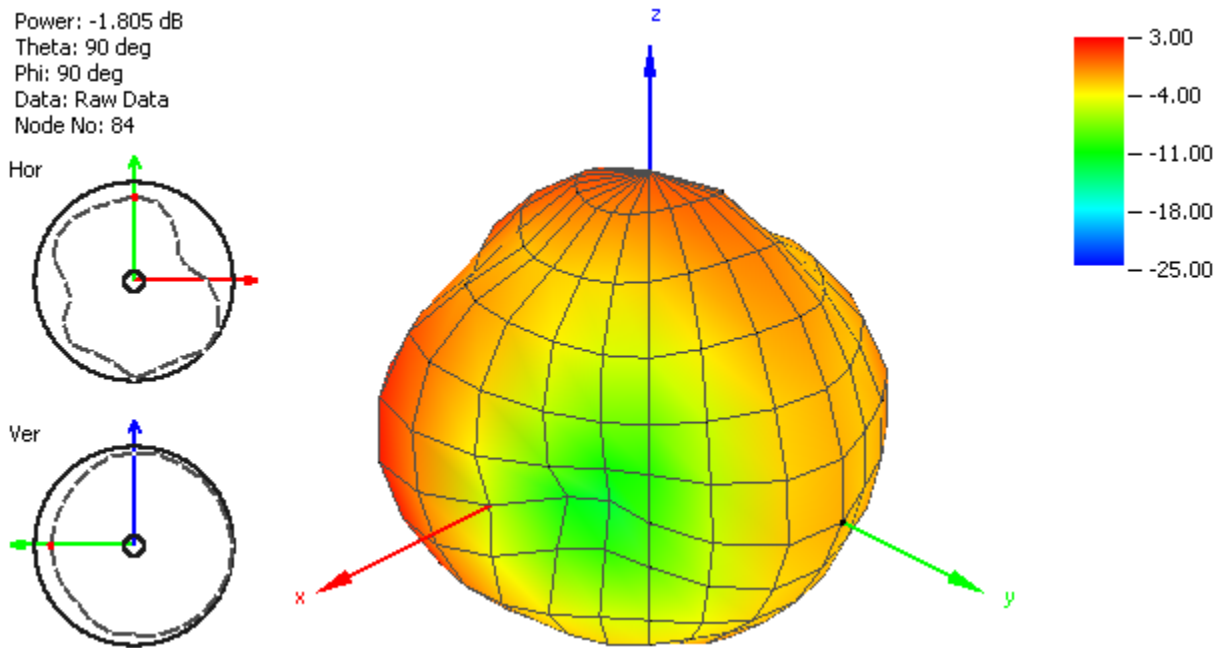

Figure 12. Radiation Pattern at 1750 MHz of FXUB63 Antenna.

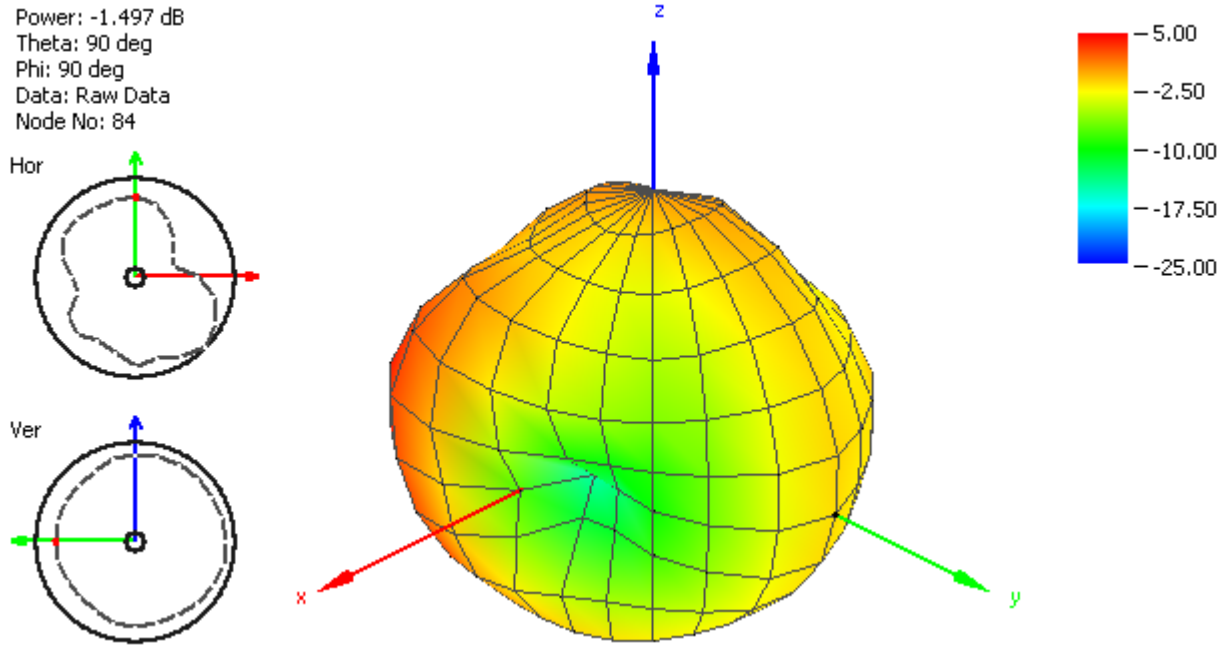

Figure 13. Radiation Pattern at 1850 MHz of FXUB63 Antenna.

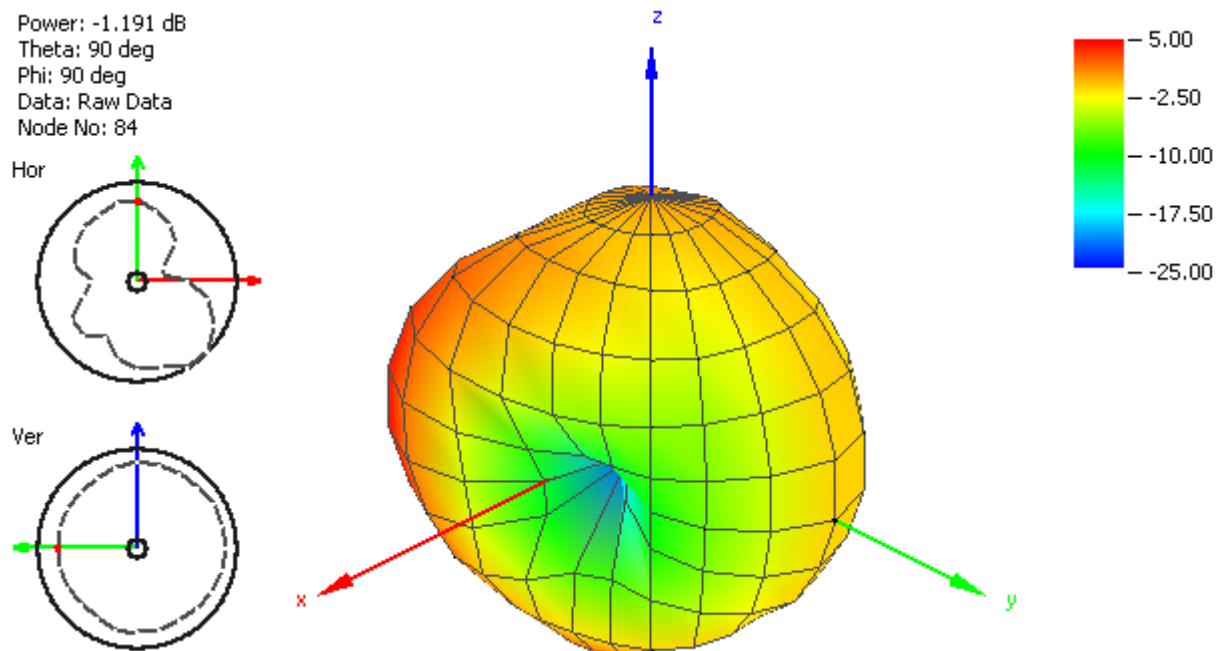

Figure 14. Radiation Pattern at 1950 MHz of FXUB63 Antenna.

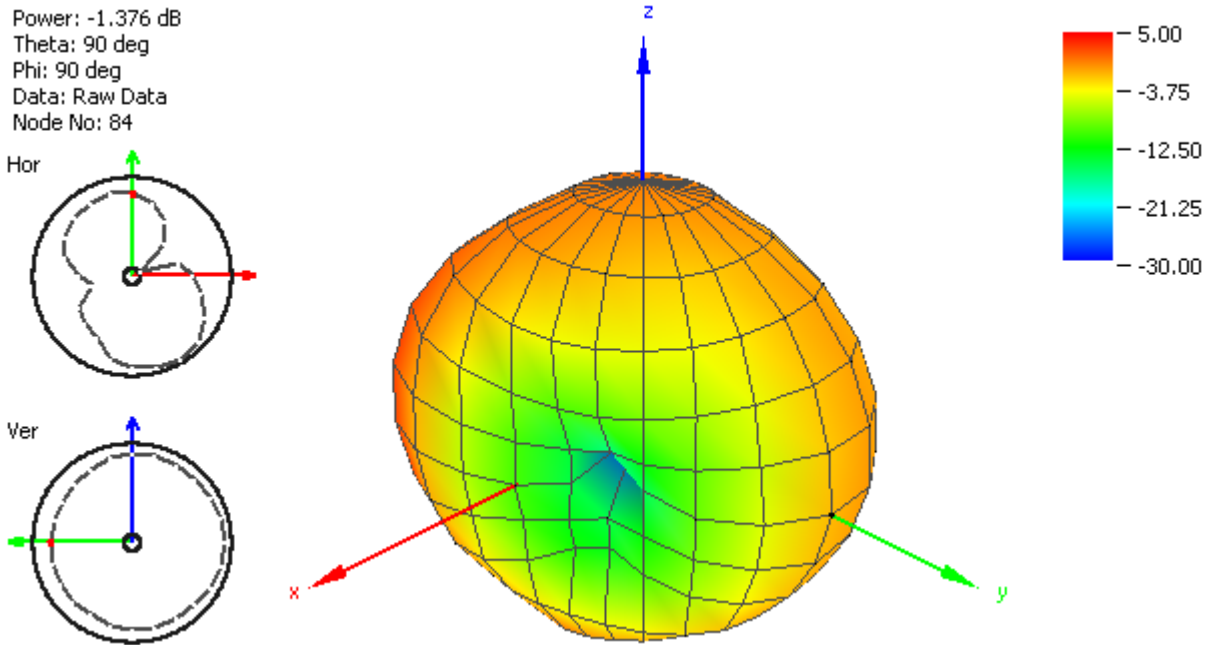

Figure 15. Radiation Pattern at 2100 MHz of FXUB63 Antenna.

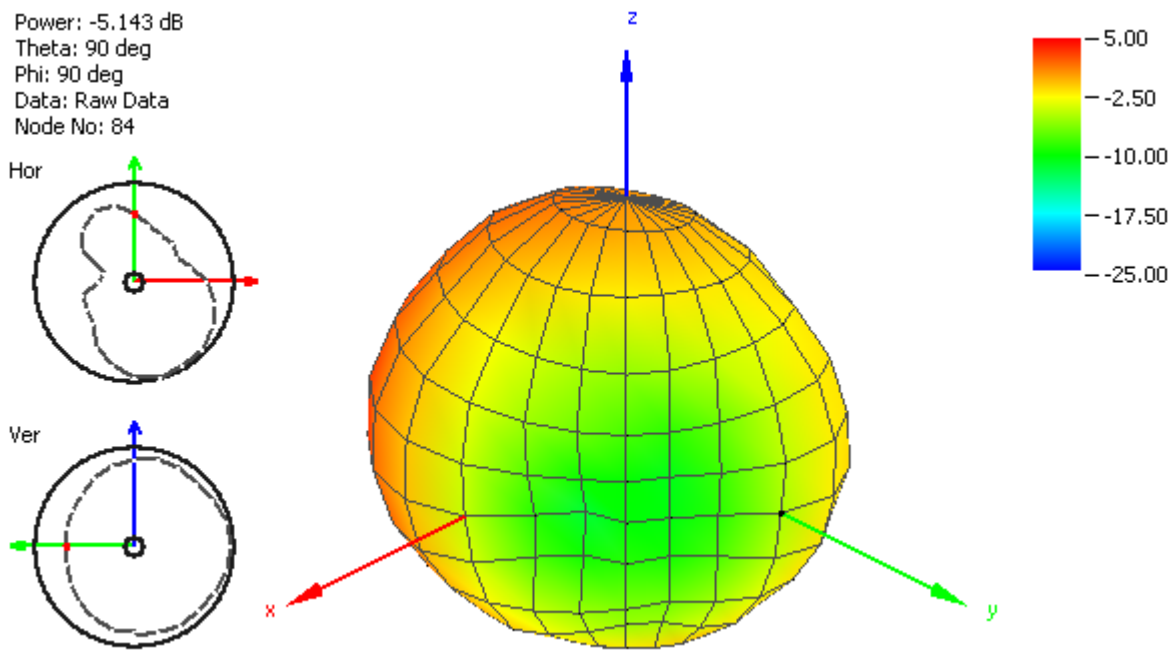

Figure 16. Radiation Pattern at 2450 MHz of FXUB63 Antenna.

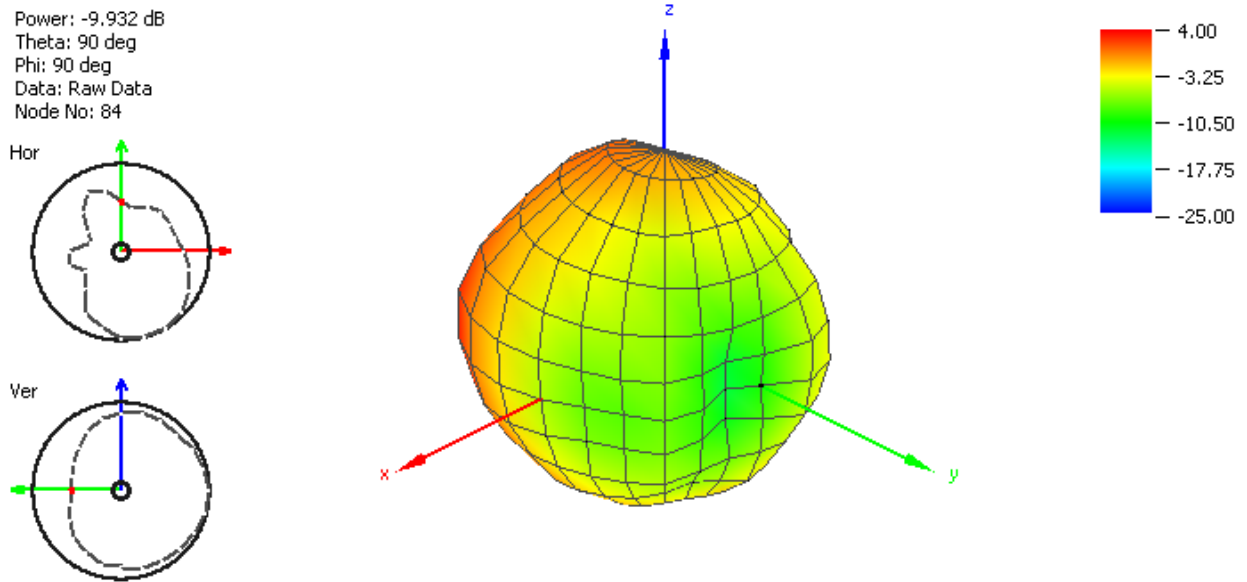

Figure 17. Radiation Pattern at 2600 MHz of FXUB63 Antenna.

4. MECHANICAL DRAWING

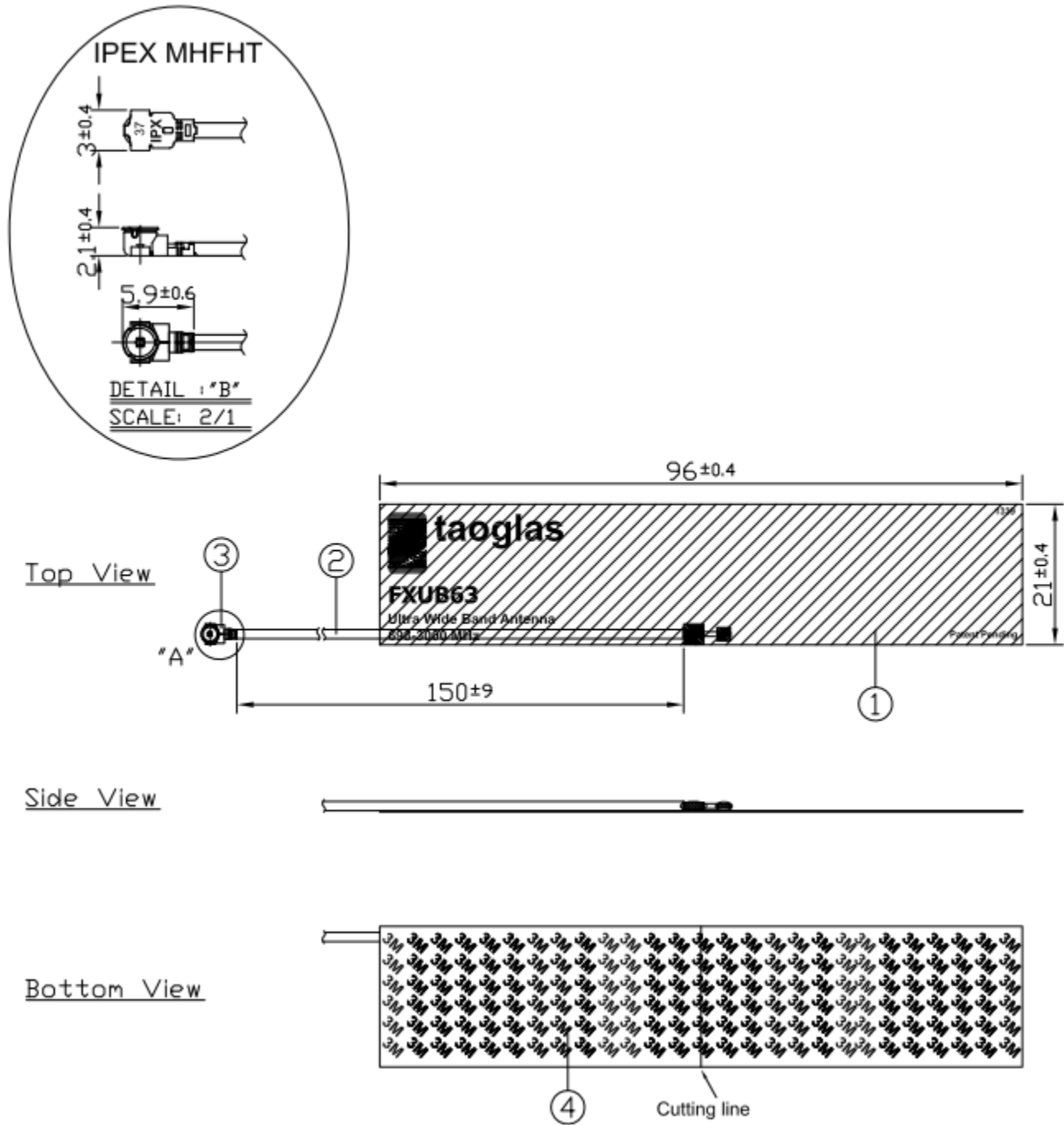

Figure 18. Mechanical drawing of FXUB63 Antenna.



5. Packaging

100 pcs FXUB63.07.0150C per PE bag
PE Bag Dimensions - 350x100mm
Weight - 150g

1000 pcs FXUB63.07.0150C per large PE bag
PE Bag Dimensions - 460x280mm
Weight - 1500g

4000 pcs FXUB63.07.0150C per carton
Carton Dimensions - 320*250*230 mm
Weight - 6Kg

Pallet Dimensions 1100*1100*1300mm
65 Cartons per Pallet
13 Cartons per layer
5 Layers

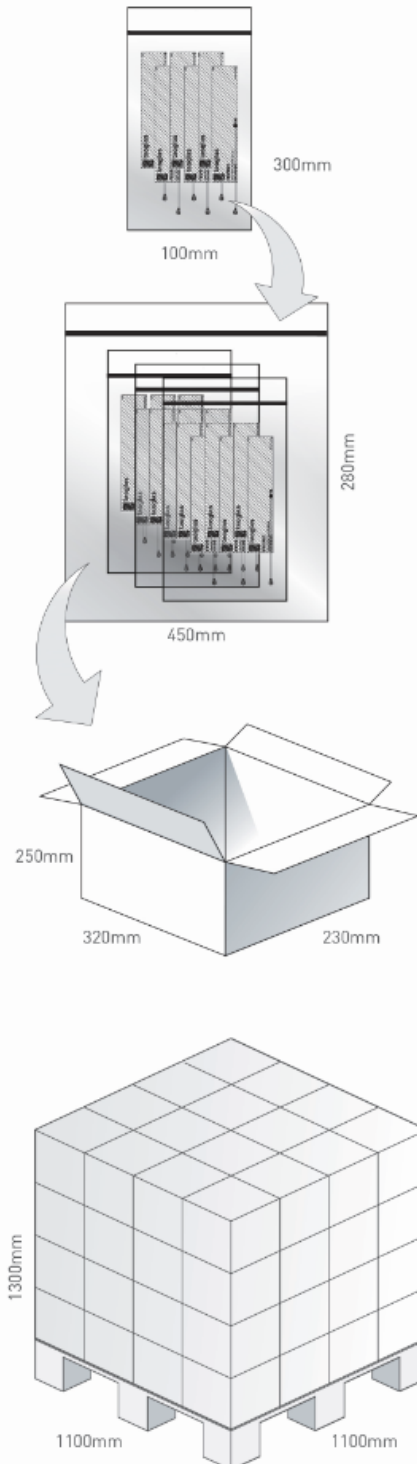



Taoglas makes no warranties based on the accuracy or completeness of the contents of this document and reserves the right to make changes to specifications and product descriptions at any time without notice.

Taoglas reserves all rights to this document and the information contained herein. Reproduction, use or disclosure to third parties without express permission is strictly prohibited.

Copyright © Taoglas Ltd.