



GaAs MMIC VOLTAGE-VARIABLE ATTENUATOR, 5 - 26.5 GHz

Typical Applications

The HMC712LP3CE is ideal for:

- Point-to-Point Radio
- VSAT Radio
- Test Instrumentation
- Microwave Sensors
- Military, ECM & Radar

Features

- Wide Bandwidth: 5 - 26.5 GHz
- Excellent Linearity: +28 dBm Input P1dB
- Wide Attenuation Range: 28 dB
- Absorptive Topology
- Singe or Dual Control Operation
- 16 Lead 3x3mm SMT Package: 9mm²

Functional Diagram

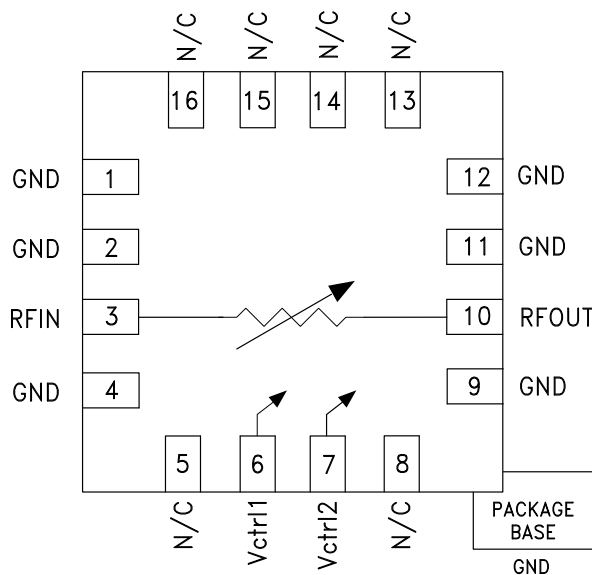

General Description

The HMC712LP3CE is an absorptive Voltage Variable Attenuator (VVA) which operates from 5 - 26.5 GHz and is ideal in designs where an analog DC control signal must be used to control RF signal levels over a 28 dB amplitude range. It features two shunt-type attenuators which are controlled by two analog voltages, Vctrl1 and Vctrl2. Optimum linearity performance of the attenuator is achieved by first varying Vctrl1 of the 1st attenuation stage from -3V to 0V with Vctrl2 fixed at -3V. The control voltage of the 2nd attenuation stage, Vctrl2, should then be varied from -3V to 0V, with Vctrl1 fixed at 0V. The HMC712LP3CE is housed in a RoHS compliant 3x3 mm QFN leadless package

However, if the Vctrl1 and Vctrl2 pins are connected together it is possible to achieve the full analog attenuation range with only a small degradation in input IP3 performance. Applications include AGC circuits and temperature compensation of multiple gain stages in microwave point-to-point and VSAT radios.

Electrical Specifications, $T_A = +25^\circ C$, 50 Ohm system

Parameter	Min.	Typ.	Max.	Units
Insertion Loss		3.5		dB
	5 - 16 GHz	4.5		dB
	16 - 24 GHz	5.5		dB
24 - 26.5 GHz				dB
Attenuation Range		28		dB
Input Return Loss		12		dB
Output Return Loss		10		dB
Input Power for 1 dB Compression (any attenuation)		28		dBm
Input Third Order Intercept (Two-tone Input Power = 10 dBm Each Tone)		32		dBm

Information furnished by Analog Devices is believed to be accurate and reliable. However, no responsibility is assumed by Analog Devices for its use, nor for any infringements of patents or other rights of third parties that may result from its use. Specifications subject to change without notice. No license is granted by implication or otherwise under any patent or patent rights of Analog Devices. Trademarks and registered trademarks are the property of their respective owners.

For price, delivery, and to place orders: Analog Devices, Inc., One Technology Way, P.O. Box 9106, Norwood, MA 02062-9106
 Phone: 781-329-4700 • Order online at www.analog.com
 Application Support: Phone: 1-800-ANALOG-D

HMC712* PRODUCT PAGE QUICK LINKS

Last Content Update: 02/23/2017

COMPARABLE PARTS

View a parametric search of comparable parts.

EVALUATION KITS

- HMC712LP3CE Evaluation Board

DOCUMENTATION

Data Sheet

- HMC712 Die Data Sheet
- HMC712LP3CE Data Sheet

REFERENCE MATERIALS

Quality Documentation

- Package/Assembly Qualification Test Report: 16L 3x3mm QFN Package (QTR: 11003 REV: 02)
- Package/Assembly Qualification Test Report: LP2, LP2C, LP3, LP3B, LP3C, LP3D, LP3F, LP3G (QTR: 2014-0364)
- Semiconductor Qualification Test Report: MESFET-F (QTR: 2013-00247)

DESIGN RESOURCES

- HMC712 Material Declaration
- PCN-PDN Information
- Quality And Reliability
- Symbols and Footprints

DISCUSSIONS

View all HMC712 EngineerZone Discussions.

SAMPLE AND BUY

Visit the product page to see pricing options.

TECHNICAL SUPPORT

Submit a technical question or find your regional support number.

DOCUMENT FEEDBACK

Submit feedback for this data sheet.



GaAs MMIC VOLTAGE-VARIABLE ATTENUATOR, 5 - 26.5 GHz

Attenuation vs. Frequency over Vctrl
Vctrl1 = Variable, Vctrl2 = -3V

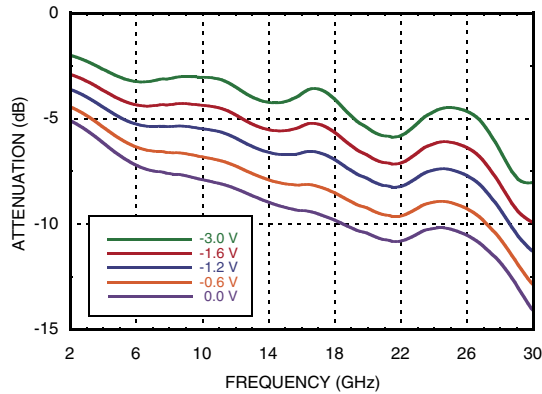

Attenuation vs. Frequency over Vctrl
Vctrl1 = 0V, Vctrl2 = Variable

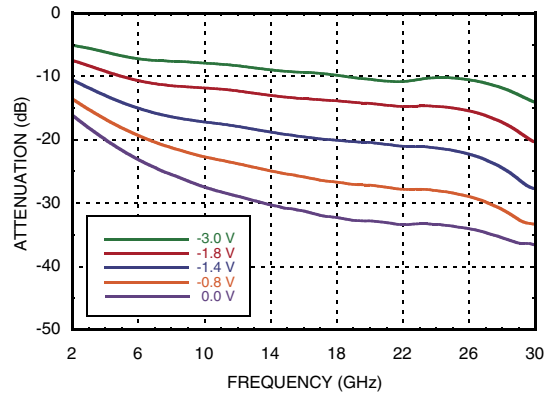

Attenuation vs. Vctrl1
Over Temperature @ 10 GHz, Vctrl2 = -3V

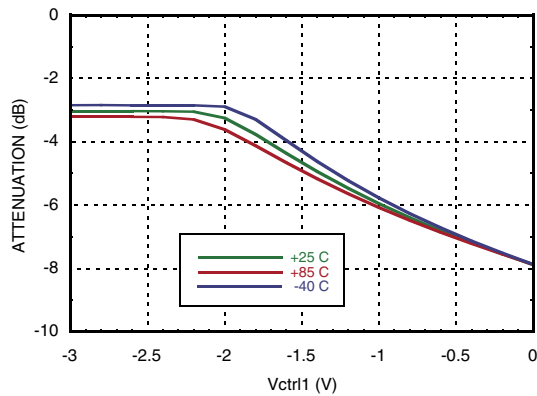

Attenuation vs. Vctrl2
Over Temperature @ 10 GHz, Vctrl1 = 0V

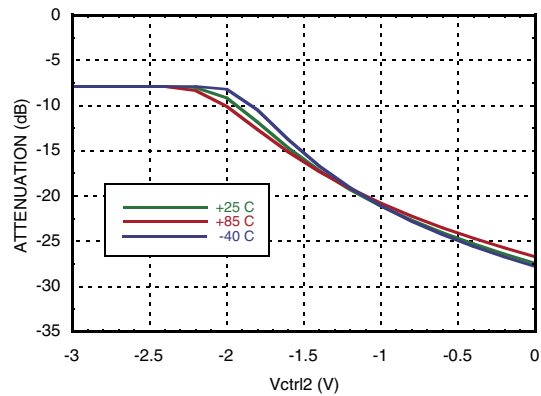

Attenuation vs. Pin @ 10 GHz
Vctrl1 = Variable, Vctrl2 = -3V

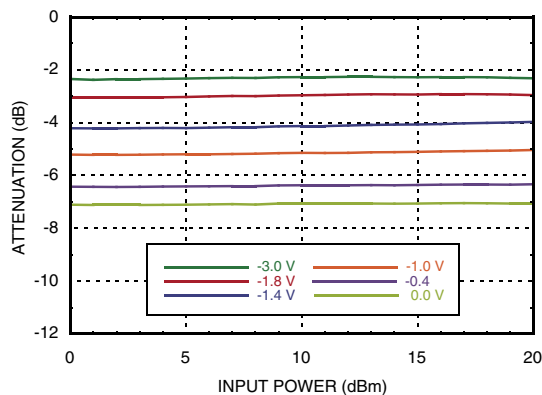

Information furnished by Analog Devices is believed to be accurate and reliable. However, no responsibility is assumed by Analog Devices for its use, nor for any infringements of patents or other rights of third parties that may result from its use. Specifications subject to change without notice. No license is granted by implication or otherwise under any patent or patent rights of Analog Devices. Trademarks and registered trademarks are the property of their respective owners.

For price, delivery, and to place orders: Analog Devices, Inc., One Technology Way, P.O. Box 9106, Norwood, MA 02062-9106 Phone: 781-329-4700 • Order online at www.analog.com Application Support: Phone: 1-800-ANALOG-D



GaAs MMIC VOLTAGE-VARIABLE ATTENUATOR, 5 - 26.5 GHz

ATTENUATOR - ANALOG - SMT

Insertion Phase vs. V_{ctrl1} , $V_{ctrl2} = -3V$

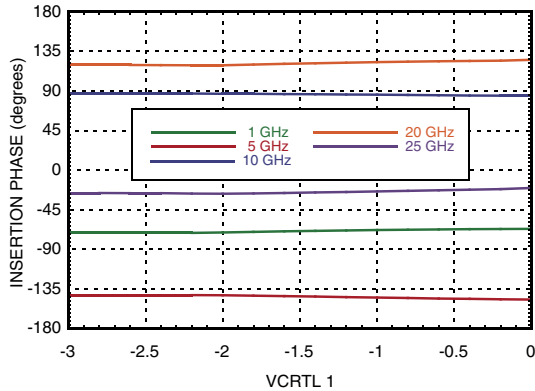

Insertion Phase vs. V_{ctrl2} , $V_{ctrl1} = 0V$

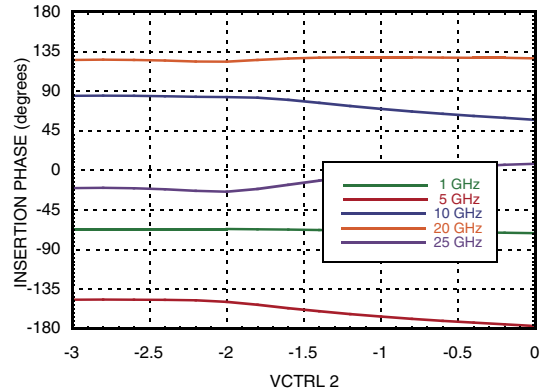

**Input Return Loss
 $V_{ctrl1} = \text{Variable}$, $V_{ctrl2} = -3V$**

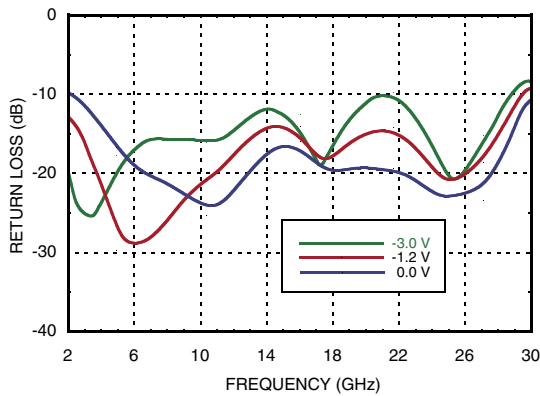

**Input Return Loss
 $V_{ctrl1} = 0V$, $V_{ctrl2} = \text{Variable}$**

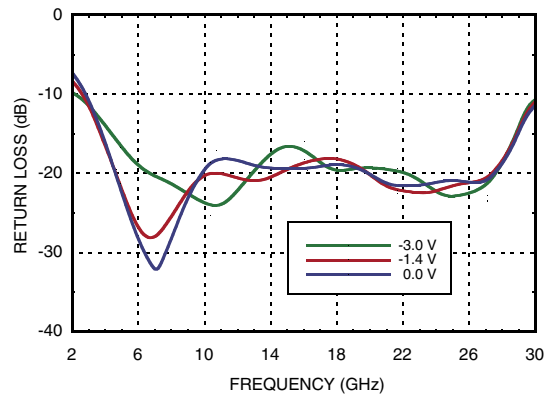

**Output Return Loss
 $V_{ctrl1} = \text{Variable}$, $V_{ctrl2} = -3V$**

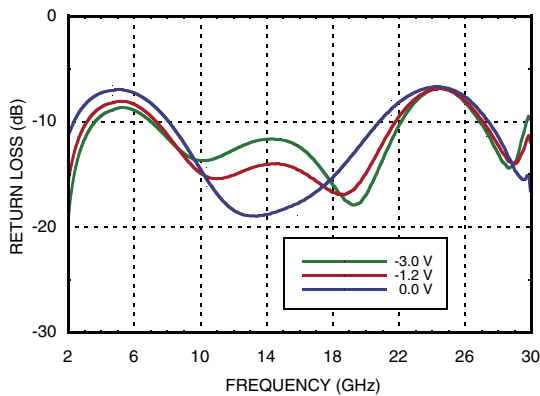

**Output Return Loss
 $V_{ctrl1} = 0V$, $V_{ctrl2} = \text{Variable}$**

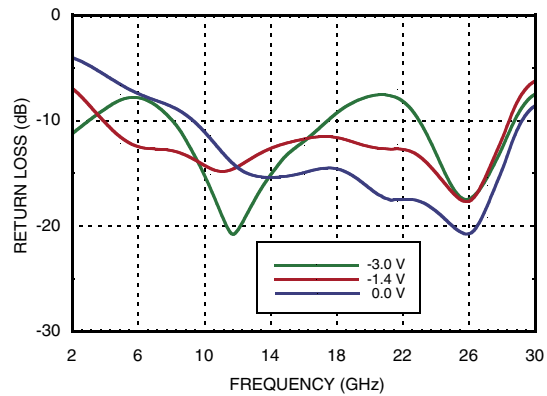

Information furnished by Analog Devices is believed to be accurate and reliable. However, no responsibility is assumed by Analog Devices for its use, nor for any infringements of patents or other rights of third parties that may result from its use. Specifications subject to change without notice. No license is granted by implication or otherwise under any patent or patent rights of Analog Devices. Trademarks and registered trademarks are the property of their respective owners.

For price, delivery, and to place orders: Analog Devices, Inc., One Technology Way, P.O. Box 9106, Norwood, MA 02062-9106 Phone: 781-329-4700 • Order online at www.analog.com Application Support: Phone: 1-800-ANALOG-D



GaAs MMIC VOLTAGE-VARIABLE ATTENUATOR, 5 - 26.5 GHz

Input IP3 vs Input Power @ 10 GHz
Vctrl1 = Variable, Vctrl2 = -3V

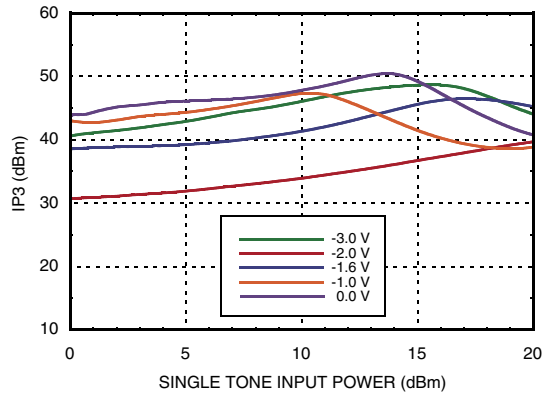

Input IP3 vs. Input Power Over Frequency
Vctrl1 = -2.0V, Vctrl2 = -3V (Worst Case IP3)

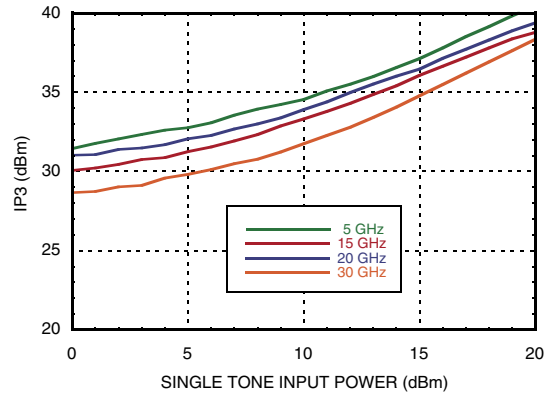

Input IP3 vs. Input Power Over Temperature
@ 10 GHz, Vctrl1 = -2.0V, Vctrl2 = -3V

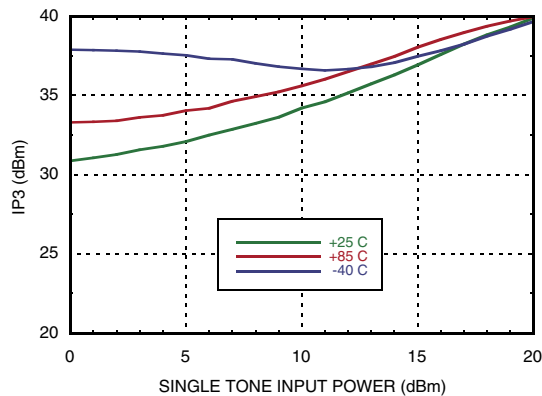

Attenuation vs. Frequency over Vctrl1
Vctrl1 = Vctrl2

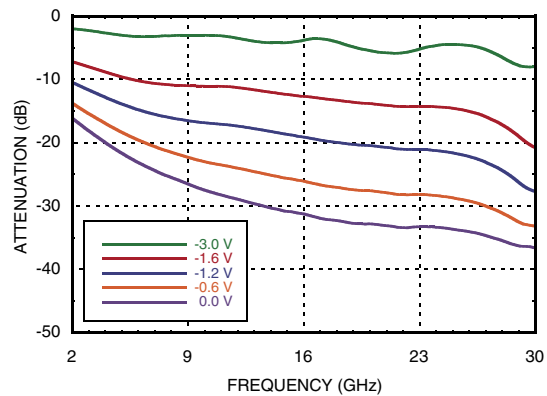

Attenuation vs. Vctrl1 over Temperature
@ 10 GHz, Vctrl1 = Vctrl2

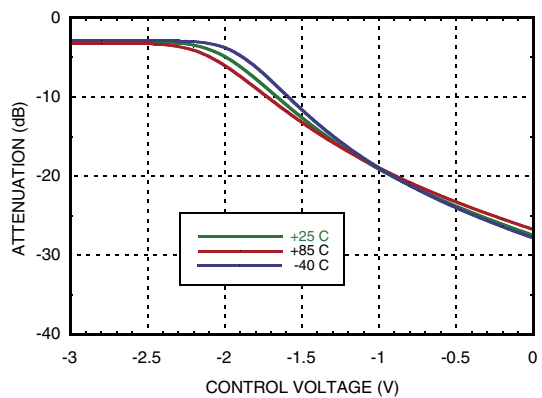

Attenuation vs. Input Power over Vctrl1
Vctrl1 = Vctrl2

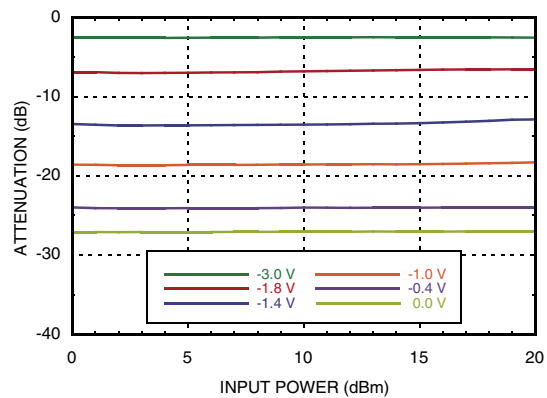



GaAs MMIC VOLTAGE-VARIABLE ATTENUATOR, 5 - 26.5 GHz

Input Return Loss, Vctrl1 = Vctrl2

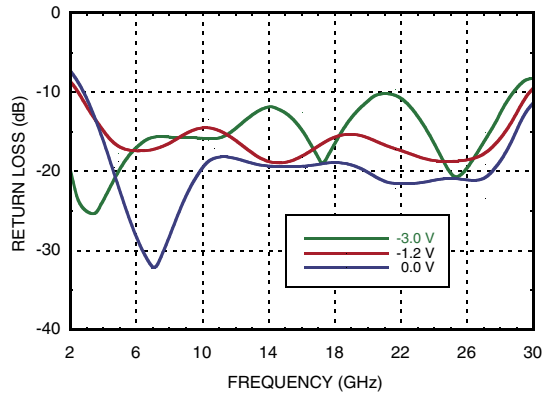

Output Return Loss, Vctrl1 = Vctrl2

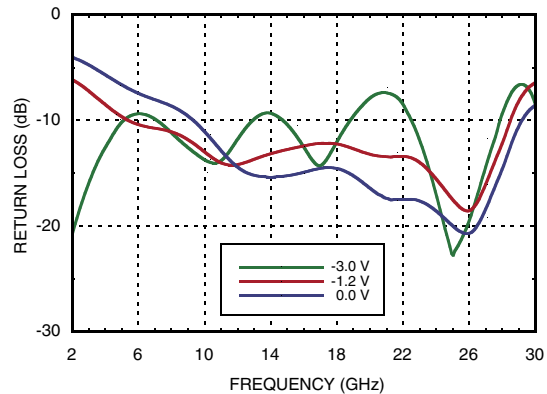

Input IP3 vs. Input Power Over Vctrl @ 10 GHz, Vctrl1 = Vctrl2

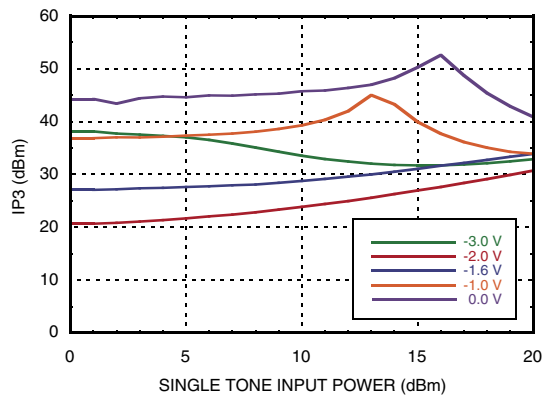

Absolute Maximum Ratings

RF Input Power	+30 dBm
Control Voltage Range	+1 to -5V
Channel Temperature	150 °C
Continuous Pdiss (T = 85 °C)	1W
Thermal Resistance (Channel to ground paddle)	66 °C/W
Storage Temperature	-65 to +150 °C
Operating Temperature	-40 to +85 °C
ESD Sensitivity (HBM)	Class 1A

Control Voltages

Vctrl1	-3 to 0V @ 10 μA
Vctrl2	-3 to 0V @ 10 μA



**ELECTROSTATIC SENSITIVE DEVICE
OBSERVE HANDLING PRECAUTIONS**



GaAs MMIC VOLTAGE-VARIABLE ATTENUATOR, 5 - 26.5 GHz

Outline Drawing

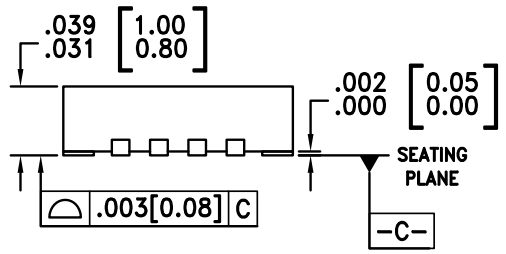
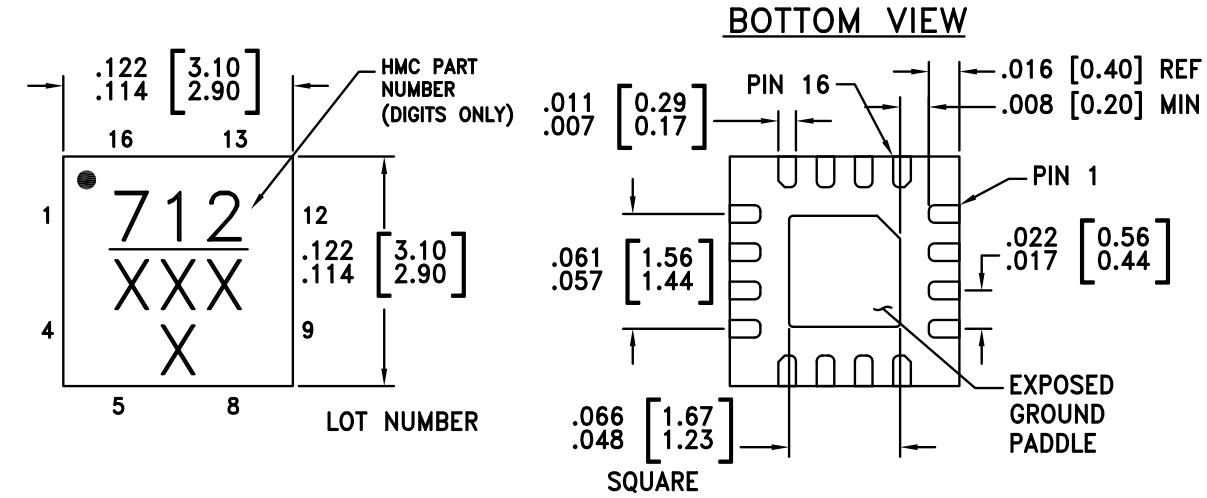

- NOTES:
1. PACKAGE BODY MATERIAL: LOW STRESS INJECTION MOLDED PLASTIC SILICA AND SILICON IMPREGNATED.
 2. LEAD AND GROUND PADDLE MATERIAL: COPPER ALLOY.
 3. LEAD AND GROUND PADDLE PLATING: 100% MATTE TIN.
 4. DIMENSIONS ARE IN INCHES [MILLIMETERS].
 5. LEAD SPACING TOLERANCE IS NON-CUMULATIVE.
 6. PAD BURR LENGTH SHALL BE 0.15mm MAX. PAD BURR HEIGHT SHALL BE 0.05mm MAX.
 7. PACKAGE WARP SHALL NOT EXCEED 0.05mm
 8. ALL GROUND LEADS AND GROUND PADDLE MUST BE SOLDERED TO PCB RF GROUND.
 9. REFER TO HITTITE APPLICATION NOTE FOR SUGGESTED PCB LAND PATTERN.

Package Information

Part Number	Package Body Material	Lead Finish	MSL Rating	Package Marking ^[1]
HMC712LP3CE	RoHS-compliant Low Stress Injection Molded Plastic	100% matte Sn	MSL1 ^[2]	H712 XXXX

[1] 4-Digit lot number XXXX
 [2] Max peak reflow temperature of 260 °C



GaAs MMIC VOLTAGE-VARIABLE ATTENUATOR, 5 - 26.5 GHz

Pin Descriptions

Pin Number	Function	Description	Interface Schematic
1, 2, 4, 9, 11, 12 Ground Paddle	GND	Ground paddle must be connected to RF/DC ground.	
3	RFIN	This pin is DC coupled and matched to 50 Ohms. A blocking capacitor is required if RF line potential is not equal to 0V.	
5, 8, 13 - 16	N/C	These pins should be connected to PCB RF ground to maximize performance.	
6	Vctrl1	Control Voltage 1	
7	Vctrl2	Control Voltage 2	
10	RFOUT	This pin is DC coupled and matched to 50 Ohms. A blocking capacitor is required if RF line potential is not equal to 0V.	

Application Circuit

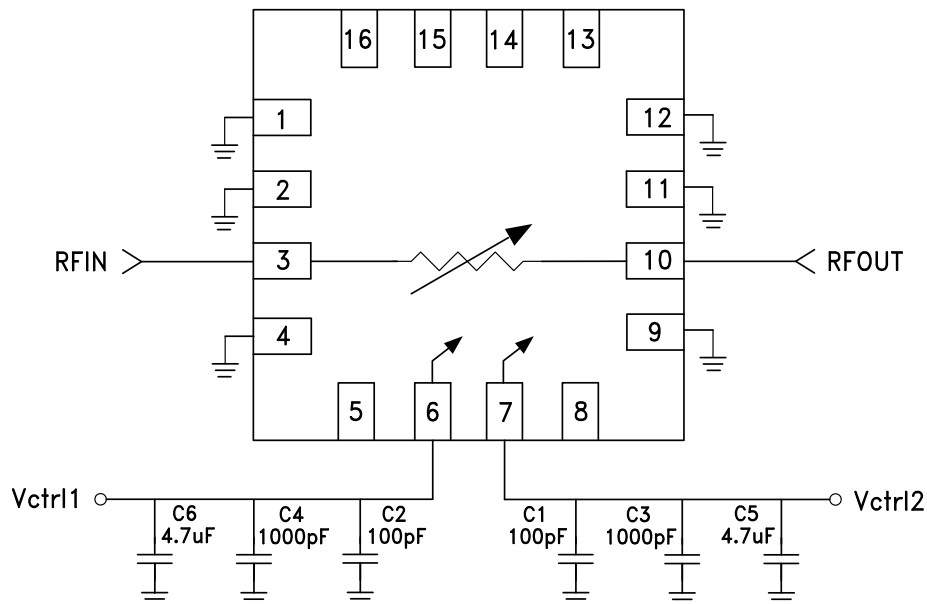

Information furnished by Analog Devices is believed to be accurate and reliable. However, no responsibility is assumed by Analog Devices for its use, nor for any infringements of patents or other rights of third parties that may result from its use. Specifications subject to change without notice. No license is granted by implication or otherwise under any patent or patent rights of Analog Devices. Trademarks and registered trademarks are the property of their respective owners.

For price, delivery, and to place orders: Analog Devices, Inc., One Technology Way, P.O. Box 9106, Norwood, MA 02062-9106
 Phone: 781-329-4700 • Order online at www.analog.com
 Application Support: Phone: 1-800-ANALOG-D



**GaAs MMIC VOLTAGE-VARIABLE
ATTENUATOR, 5 - 26.5 GHz**

Evaluation PCB

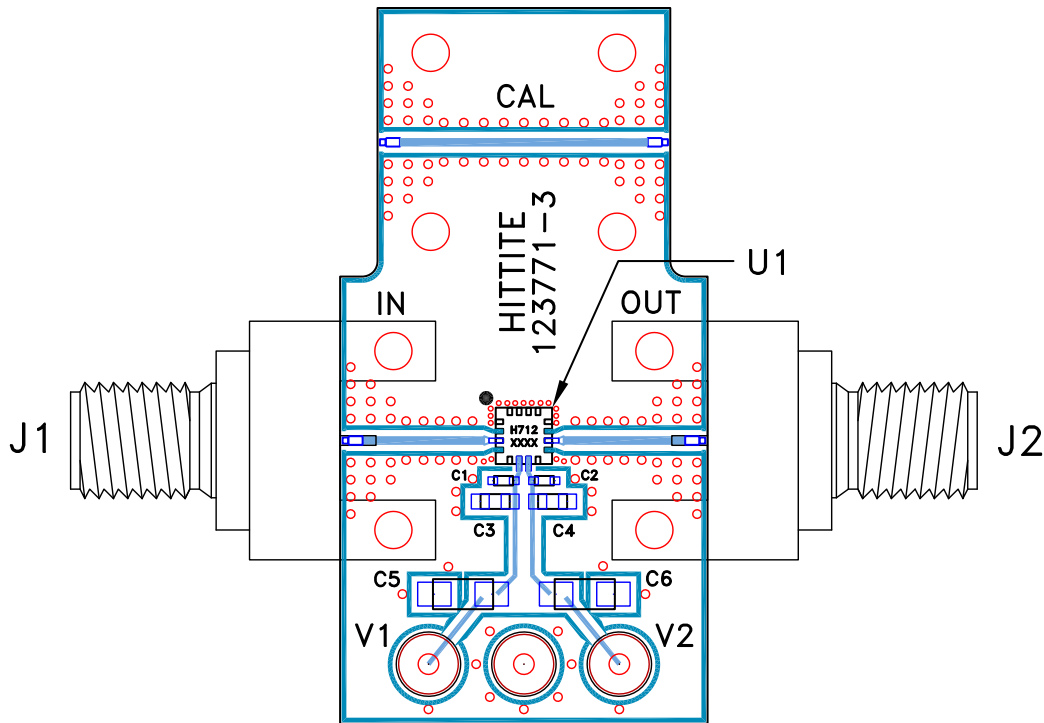

List of Materials for Evaluation PCB 123773 [1]

Item	Description
J1, J2	PCB Mount SMA RF Connector
C1, C2	100 pF Capacitor, 0402 Pkg.
C3, C4	1000 pF Capacitor, 0603 Pkg.
C5, C6	4.7 μF Capacitor, Tantalum
V1, V2	DC Pin
U1	HMC712LP3CE Voltage Variable Attenuator
PCB [2]	123771 Evaluation PCB

[1] Reference this number when ordering complete evaluation PCB

[2] Circuit Board Material: Arlon 25FR or Rogers 4350

The circuit board used in the final application should use RF circuit design techniques. Signal lines should have 50 Ohm impedance while the package ground leads and exposed paddle should be connected directly to the ground plane similar to that shown. A sufficient number of via holes should be used to connect the top and bottom ground planes. The evaluation circuit board shown is available from Hittite upon request.