





Grayhill, Inc.

62S11-M0-020C

Teilenummer:	62S11-M0-020C
Hersteller / Marke:	Grayhill, Inc.
Produktbeschreibung	ROTARY ENCODER OPT 32PPR 2" CBL
Datenblätter:	 62S11-M0-020C.pdf
RoHS Status	 Bleifrei / RoHS-konform
Zustand des Lagers	1812 pcs stock
Liefern von	Hongkong
Versandweg	DHL/Fedex/TNT/UPS/EMS



ANGEBOTSANFRAGE

Bild kann Darstellung sein. Siehe Spezifikationen für Produktdetails.





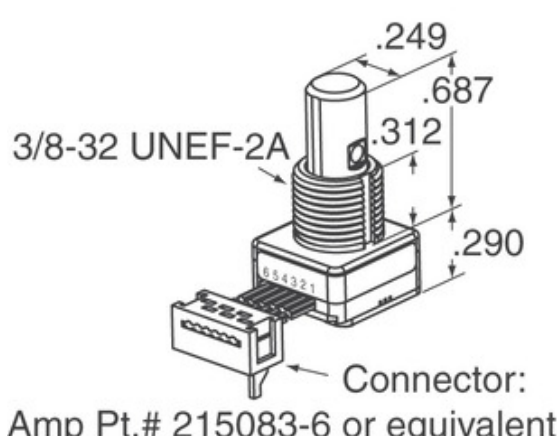

Spezifikationen von 62S11-M0-020C

TEILENUMMER	62S11-M0-020C
HERSTELLER	Grayhill, Inc.
BESCHREIBUNG	ROTARY ENCODER OPT 32PPR 2" CBL
BLEIFREIER STATUS / ROHS STATUS	Bleifrei / RoHS-konform
VERFÜGBARE MENGE	1812 pcs
DATENBLATT	 62S11-M0-020C.pdf
SPANNUNGSVERSORGUNG	5V
ABSCHLUSSART	Cable with Connector
SERIE	62S
ROTATIONSLEBENSDAUER (ZYKLEN MIN)	1M
IMPULSE PRO UMDREHUNG	32
AUSGABETYP	Quadrature (Incremental)
ORIENTIERUNG	Vertical
BEFESTIGUNGSART	Panel Mount
FEUCHTIGKEITSEMPFINDLICHKEITSNIVEAU (MSL)	1 (Unlimited)
BLEIFREIER STATUS / ROHS-STATUS	Lead free / RoHS Compliant
ENCODERTYP	Optical
RASTE	Yes
INTEGRIERTER SCHALTER	No
BETÄTIGERTYP	1/4" Dia Flatted End

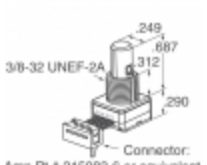
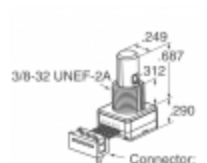
Verwandte Tags

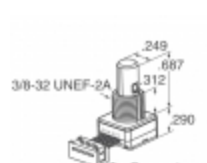
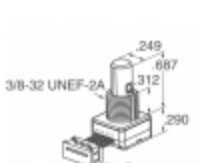
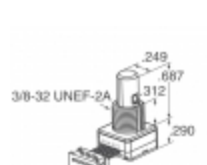
Grayhill, Inc. 62S11-M0-020C	62S11-M0-020C-Vertriebspartner	62S11-M0-020C Lieferant
62S11-M0-020C Preis	62S11-M0-020C Bilder	62S11-M0-020C-Bild
62S11-M0-020C PDF-Datenblatt	62S11-M0-020C Datenblatt herunterladen	62S11-M0-020C Datenblatt
62S11-M0-020C-Bestand	62S11-M0-020C kaufen	Grayhill, Inc. kaufen 62S11-M0-020C
Grayhill, Inc. 62S11-M0-020C	Grayhill, Inc. Lieferant	Grayhill, Inc.-Vertriebspartner
Grayhill, Inc. 62S11-M0-020C	Grayhill Inc. 62S11-M0-020C	

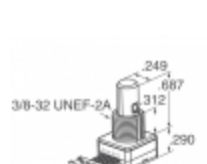
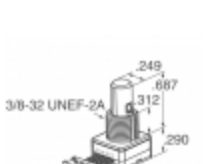
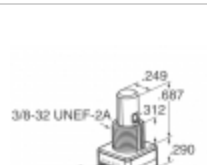
Verwandte Produkte

 <p>62S11-L9-020C Hersteller: Grayhill, Inc. Beschreibung: ROTARY ENCODER OPTICAL 32PPR Auf Lager: 1773 pcs</p> <p>RFQ</p>	 <p>62S11-M0-030CH Hersteller: Grayhill, Inc. Beschreibung: ROTARY ENCODER OPTICAL 32PPR Auf Lager: 2151 pcs</p> <p>RFQ</p>
 <p>62S11-M0-020SH Hersteller: Grayhill, Inc. Beschreibung: ROTARY ENCODER OPT 32PPR 2" CBL Auf Lager: 2051 pcs</p> <p>RFQ</p>	 <p>62S11-M0-050C Hersteller: Grayhill, Inc. Beschreibung: ROTARY ENCODER OPT 32PPR 5" CBL Auf Lager: 2292 pcs</p> <p>RFQ</p>
 <p>62S11-L9-PH Hersteller: Grayhill, Inc. Beschreibung: ROTARY ENCODER OPTICAL 32PPR Auf Lager: 1972 pcs</p> <p>RFQ</p>	 <p>62S11-M0-060CH Hersteller: Grayhill, Inc. Beschreibung: ROTARY ENCODER OPTICAL 32PPR Auf Lager: 1968 pcs</p> <p>RFQ</p>
 <p>62S11-L9-040C Hersteller: Grayhill, Inc. Beschreibung: ROTARY ENCODER OPTICAL 32PPR Auf Lager: 1938 pcs</p> <p>RFQ</p>	 <p>62S11-M0-060C Hersteller: Grayhill, Inc. Beschreibung: ROTARY ENCODER OPT 32PPR 6" CBL Auf Lager: 2289 pcs</p> <p>RFQ</p>
 <p>62S11-L9-020S Hersteller: Grayhill, Inc. Beschreibung: ROTARY ENCODER OPTICAL 32PPR Auf Lager: 2134 pcs</p> <p>RFQ</p>	 <p>62S11-L9-020CH Hersteller: Grayhill, Inc. Beschreibung: ROTARY ENCODER OPTICAL 32PPR Auf Lager: 2264 pcs</p> <p>RFQ</p>
 <p>62S11-L9-020SH Hersteller: Grayhill, Inc. Beschreibung: ROTARY ENCODER OPTICAL 32PPR Auf Lager: 1952 pcs</p> <p>RFQ</p>	 <p>62S11-M0-040CH Hersteller: Grayhill, Inc. Beschreibung: ROTARY ENCODER OPT 32PPR 2" CBL Auf Lager: 1915 pcs</p> <p>RFQ</p>

Copyright © 2020 Zuverlässiger Distributor von elektronischen Komponenten

Email: Info@infinity-electronic.com

Adresse: 17F, Gaylord Geschäftshaus, 114-118 Lockhart Road, Wan Chai, Hongkong

