

Panasonic

Panasonic

HE1AN-P-DC9V-H18

Teilenummer:

Hersteller / Marke:

Produktbeschreibung

Datenblätter:

RoHS Status

Zustand des Lagers

Lieferr von

Versandweg

HE1AN-P-DC9V-H18

Panasonic

HE RELAYS 1 FORM A 9VDC

 HE1AN-P-DC9V-H18.pdf

 Bleifrei / RoHS-konform

4621 pcs stock

Hongkong

DHL/Fedex/TNT/UPS/EMS



Bild kann Darstellung sein. Siehe Spezifikationen für Produktdetails.

[ANGEBOTSANFRAGE](#)





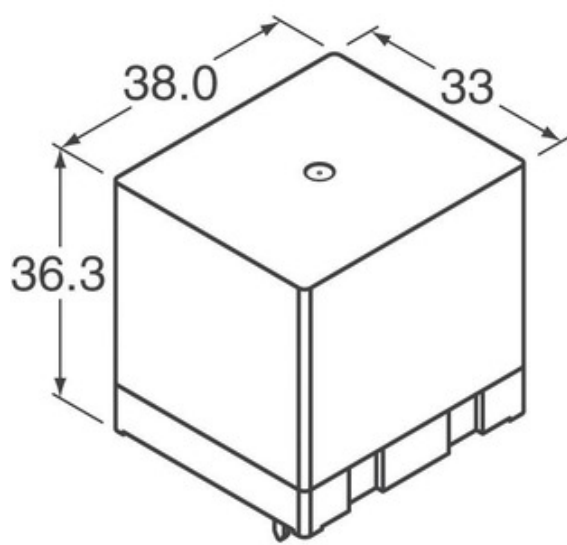





Spezifikationen von HE1AN-P-DC9V-H18

TEILENUMMER	HE1AN-P-DC9V-H18
HERSTELLER	Panasonic
BESCHREIBUNG	HE RELAYS 1 FORM A 9VDC
BLEIFREIER STATUS / ROHS STATUS	Bleifrei / RoHS-konform
VERFÜGBARE MENGE	4621 pcs
DATENBLATT	 HE1AN-P-DC9V-H18.pdf
SERIE	*
FEUCHTIGKEITSEMPFINDLICHKEITSNIVEAU (MSL)	1 (Unlimited)
BLEIFREIER STATUS / ROHS-STATUS	Lead free / RoHS Compliant
DETAILLIERTE BESCHREIBUNG	Relay Coil

Verwandte Tags

Panasonic HE1AN-P-DC9V-H18	HE1AN-P-DC9V-H18-Vertriebspartner	HE1AN-P-DC9V-H18 Lieferant
HE1AN-P-DC9V-H18 Preis	HE1AN-P-DC9V-H18 Bilder	HE1AN-P-DC9V-H18-Bild
HE1AN-P-DC9V-H18 PDF-Datenblatt	HE1AN-P-DC9V-H18 Datenblatt herunterladen	HE1AN-P-DC9V-H18 Datenblatt
HE1AN-P-DC9V-H18-Bestand	HE1AN-P-DC9V-H18 kaufen	Panasonic kaufen HE1AN-P-DC9V-H18
Panasonic HE1AN-P-DC9V-H18	Panasonic Lieferant	Panasonic-Vertriebspartner
Panasonic HE1AN-P-DC9V-H18	Panasonic - Consumer Division HE1AN-P-DC9V-H18	Panasonic - Consumer Electronics Corp. HE1AN-P-DC9V-H18
Panasonic Battery Group HE1AN-P-DC9V-H18	Panasonic Electric Works - ACSD HE1AN-P-DC9V-H18	Panasonic Electronic Components - Semiconductor Pr HE1AN-P-DC9V-H18
Panasonic - ATG HE1AN-P-DC9V-H18	Panasonic - BSG HE1AN-P-DC9V-H18	Panasonic - DTG HE1AN-P-DC9V-H18
Panasonic Electric Works HE1AN-P-DC9V-H18	Panasonic Electronic Components HE1AN-P-DC9V-H18	Panasonic Industrial Automation Sales HE1AN-P-DC9V-H18
Panasonic Semiconductor HE1AN-P-DC9V-H18		

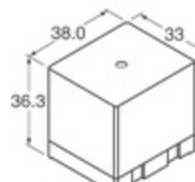
Verwandte Produkte

 <p>HE1AN-Q-AC24V Hersteller: Panasonic Beschreibung: RELAY GEN PURPOSE SPST 30A 24V Auf Lager: 3984 pcs</p> <p>RFQ</p>	 <p>HE1AN-Q-AC240V Hersteller: Panasonic Beschreibung: RELAY GEN PURPOSE SPST 30A 240V Auf Lager: 4724 pcs</p> <p>RFQ</p>
 <p>HE1AN-Q-AC12V Hersteller: Panasonic Beschreibung: RELAY GEN PURPOSE SPST 30A 12V Auf Lager: 3671 pcs</p> <p>RFQ</p>	 <p>HE1AN-P-DC24V Hersteller: Panasonic Beschreibung: RELAY GEN PURPOSE SPST 30A 24V Auf Lager: 5103 pcs</p> <p>RFQ</p>
 <p>HE1AN-P-DC48V Hersteller: Panasonic Beschreibung: RELAY GEN PURPOSE SPST 30A 48V Auf Lager: 4726 pcs</p> <p>RFQ</p>	 <p>HE1AN-P-DC12V-Y5 Hersteller: Panasonic Beschreibung: RELAY GEN PURPOSE SPST 48A 12V Auf Lager: 2508 pcs</p> <p>RFQ</p>
 <p>HE1AN-P-DC6V-Y5 Hersteller: Panasonic Beschreibung: RELAY GEN PURPOSE SPST 48A 6V Auf Lager: 2679 pcs</p> <p>RFQ</p>	 <p>HE1AN-P-DC9V-Y5 Hersteller: Panasonic Beschreibung: RELAY GEN PURPOSE SPST 48A 9V Auf Lager: 2911 pcs</p> <p>RFQ</p>
 <p>HE1AN-Q-AC120V Hersteller: Panasonic Beschreibung: RELAY GEN PURPOSE SPST 30A 120V Auf Lager: 4652 pcs</p> <p>RFQ</p>	 <p>HE1AN-P-DC9V-Y4 Hersteller: Panasonic Beschreibung: HE RELAYS 1 FORM A 9VDC Auf Lager: 4805 pcs</p> <p>RFQ</p>
 <p>HE1AN-P-DC24V-Y5 Hersteller: Panasonic Beschreibung: RELAY GEN PURPOSE SPST 48A 24V Auf Lager: 2622 pcs</p> <p>RFQ</p>	 <p>HE1AN-P-DC12V-H18 Hersteller: Panasonic Beschreibung: RELAY GEN PURPOSE SPST 35A 12V Auf Lager: 6470 pcs</p> <p>RFQ</p>

Copyright © 2020 Zuverlässiger Distributor von elektronischen Komponenten

Email: Info@infinity-electronic.com

Adresse: 17F, Gaylord Geschäftshaus, 114-118 Lockhart Road, Wan Chai, Hongkong

