





Grayhill, Inc.

62S11-L9-040C

Teilenummer:	62S11-L9-040C
Hersteller / Marke:	Grayhill, Inc.
Produktbeschreibung	ROTARY ENCODER OPTICAL 32PPR
Datenblätter:	 62S11-L9-040C.pdf
RoHS Status	 Bleifrei / RoHS-konform
Zustand des Lagers	1938 pcs stock
Liefern von	Hongkong
Versandweg	DHL/Fedex/TNT/UPS/EMS



[ANGEBOTSANFRAGE](#)

Bild kann Darstellung sein. Siehe Spezifikationen für Produktdetails.



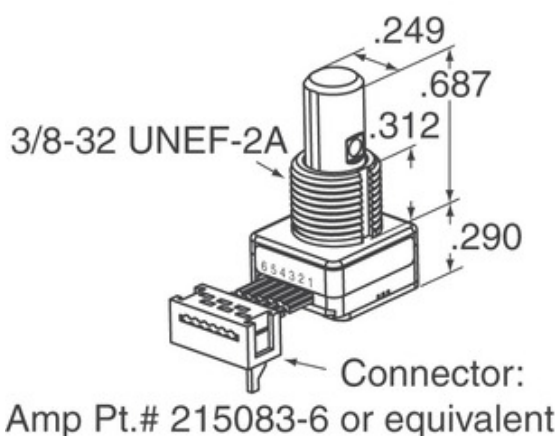

Spezifikationen von 62S11-L9-040C

TEILENUMMER	62S11-L9-040C
HERSTELLER	Grayhill, Inc.
BESCHREIBUNG	ROTARY ENCODER OPTICAL 32PPR
BLEIFREIER STATUS / ROHS STATUS	Bleifrei / RoHS-konform
VERFÜGBARE MENGE	1938 pcs
DATENBLATT	 62S11-L9-040C.pdf
SPANNUNGSVERSORGUNG	5V
ABSCHLUSSART	Cable with Connector
SERIE	62S
ROTATIONSLEBENSDAUER (ZYKLEN MIN)	1M
IMPULSE PRO UMDREHUNG	32
AUSGABETYP	Quadrature (Incremental)
ANDERE NAMEN	62S11L9040C
ORIENTIERUNG	Vertical
BEFESTIGUNGSART	Panel Mount
FEUCHTIGKEITSEMPFINDLICHKEITSNIVEAU (MSL)	1 (Unlimited)
BLEIFREIER STATUS / ROHS-STATUS	Lead free / RoHS Compliant
ENCODERTYP	Optical
RASTE	Yes
INTEGRIERTER SCHALTER	Yes
BETÄTIGERTYP	1/4" Dia Flatted End

Verwandte Tags

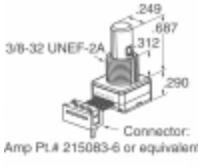
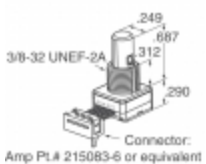
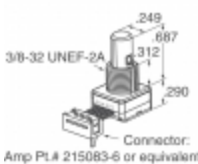
Grayhill, Inc. 62S11-L9-040C	62S11-L9-040C-Vertriebspartner	62S11-L9-040C Lieferant
62S11-L9-040C Preis	62S11-L9-040C Bilder	62S11-L9-040C-Bild
62S11-L9-040C PDF-Datenblatt	62S11-L9-040C Datenblatt herunterladen	62S11-L9-040C Datenblatt
62S11-L9-040C-Bestand	62S11-L9-040C kaufen	Grayhill, Inc. kaufen 62S11-L9-040C
Grayhill, Inc. 62S11-L9-040C	Grayhill, Inc. Lieferant	Grayhill, Inc.-Vertriebspartner
Grayhill, Inc. 62S11-L9-040C	Grayhill Inc. 62S11-L9-040C	

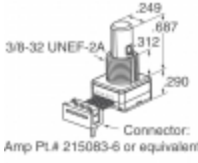
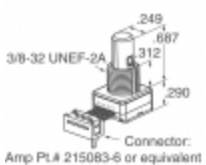
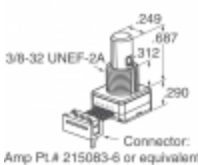
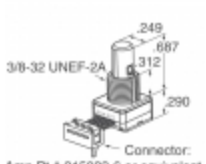
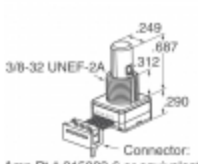
Verwandte Produkte

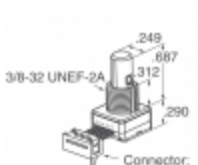
 <p>62S11-L5-PH Hersteller: Grayhill, Inc. Beschreibung: ROTARY ENCODER OPTICAL 32PPR Auf Lager: 2218 pcs</p> <p>RFQ</p>	 <p>62S11-L9-020C Hersteller: Grayhill, Inc. Beschreibung: ROTARY ENCODER OPTICAL 32PPR Auf Lager: 1773 pcs</p> <p>RFQ</p>
 <p>62S11-M0-020C Hersteller: Grayhill, Inc. Beschreibung: ROTARY ENCODER OPT 32PPR 2" CBL Auf Lager: 1812 pcs</p> <p>RFQ</p>	 <p>62S11-L9-PH Hersteller: Grayhill, Inc. Beschreibung: ROTARY ENCODER OPTICAL 32PPR Auf Lager: 1972 pcs</p> <p>RFQ</p>
 <p>62S11-M0-040CH Hersteller: Grayhill, Inc. Beschreibung: ROTARY ENCODER OPT 32PPR 2" CBL Auf Lager: 1915 pcs</p> <p>RFQ</p>	 <p>62S11-L9-020S Hersteller: Grayhill, Inc. Beschreibung: ROTARY ENCODER OPTICAL 32PPR Auf Lager: 2134 pcs</p> <p>RFQ</p>
 <p>62S11-M0-020SH Hersteller: Grayhill, Inc. Beschreibung: ROTARY ENCODER OPT 32PPR 2" CBL Auf Lager: 2051 pcs</p> <p>RFQ</p>	 <p>62S11-L5-P Hersteller: Grayhill, Inc. Beschreibung: ROTARY ENCODER OPTICAL 32PPR Auf Lager: 2265 pcs</p> <p>RFQ</p>
 <p>62S11-M0-030CH Hersteller: Grayhill, Inc. Beschreibung: ROTARY ENCODER OPTICAL 32PPR Auf Lager: 2151 pcs</p> <p>RFQ</p>	 <p>62S11-L9-020CH Hersteller: Grayhill, Inc. Beschreibung: ROTARY ENCODER OPTICAL 32PPR Auf Lager: 2264 pcs</p> <p>RFQ</p>
 <p>62S11-M0-050C Hersteller: Grayhill, Inc. Beschreibung: ROTARY ENCODER OPT 32PPR 5" CBL Auf Lager: 2292 pcs</p> <p>RFQ</p>	 <p>62S11-L9-020SH Hersteller: Grayhill, Inc. Beschreibung: ROTARY ENCODER OPTICAL 32PPR Auf Lager: 1952 pcs</p> <p>RFQ</p>

Copyright © 2020 Zuverlässiger Distributor von elektronischen Komponenten

Email: Info@infinity-electronic.com

Adresse: 17F, Gaylord Geschäftshaus, 114-118 Lockhart Road, Wan Chai, Hongkong

