





Grayhill, Inc.

62S11-N4-025CH

Teilenummer:	62S11-N4-025CH
Hersteller / Marke:	Grayhill, Inc.
Produktbeschreibung	ROTARY ENCODER OPTICAL 32PPR
Datenblätter:	 62S11-N4-025CH.pdf
RoHS Status	 Bleifrei / RoHS-konform
Zustand des Lagers	1946 pcs stock
Liefern von	Hongkong
Versandweg	DHL/Fedex/TNT/UPS/EMS



[ANGEBOTSANFRAGE](#)

Bild kann Darstellung sein. Siehe Spezifikationen für Produktdetails.



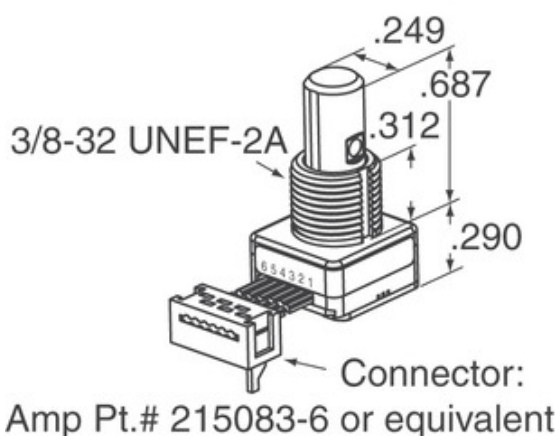

Spezifikationen von 62S11-N4-025CH

TEILENUMMER	62S11-N4-025CH
HERSTELLER	Grayhill, Inc.
BESCHREIBUNG	ROTARY ENCODER OPTICAL 32PPR
BLEIFREIER STATUS / ROHS STATUS	Bleifrei / RoHS-konform
VERFÜGBARE MENGE	1946 pcs
DATENBLATT	 62S11-N4-025CH.pdf
SPANNUNGSVERSORGUNG	5V
ABSCHLUSSART	Cable with Connector
SERIE	62S
ROTATIONSLEBENSDAUER (ZYKLEN MIN)	1M
IMPULSE PRO UMDREHUNG	32
AUSGABETYP	Quadrature (Incremental)
ANDERE NAMEN	62S11N4025CH
ORIENTIERUNG	Vertical
BEFESTIGUNGSART	Panel Mount
FEUCHTIGKEITSEMPFINDLICHKEITSNIVEAU (MSL)	1 (Unlimited)
BLEIFREIER STATUS / ROHS-STATUS	Lead free / RoHS Compliant
ENCODERTYP	Optical
RASTE	No
INTEGRIERTER SCHALTER	Yes
BETÄTIGERTYP	1/4" Dia Flatted End

Verwandte Tags

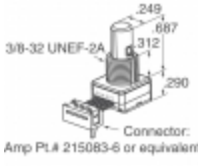
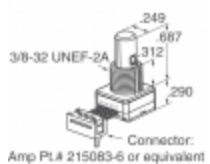
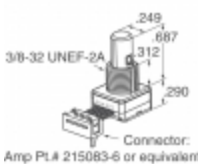
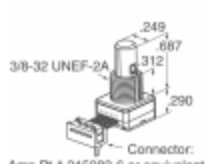
Grayhill, Inc. 62S11-N4-025CH	62S11-N4-025CH-Vertriebspartner	62S11-N4-025CH Lieferant
62S11-N4-025CH Preis	62S11-N4-025CH Bilder	62S11-N4-025CH-Bild
62S11-N4-025CH PDF-Datenblatt	62S11-N4-025CH Datenblatt herunterladen	62S11-N4-025CH Datenblatt
62S11-N4-025CH-Bestand	62S11-N4-025CH kaufen	Grayhill, Inc. kaufen 62S11-N4-025CH
Grayhill, Inc. 62S11-N4-025CH	Grayhill, Inc. Lieferant	Grayhill, Inc.-Vertriebspartner
Grayhill, Inc. 62S11-N4-025CH	Grayhill Inc. 62S11-N4-025CH	

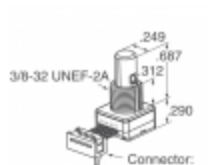
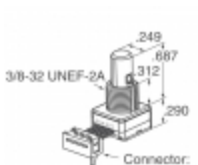
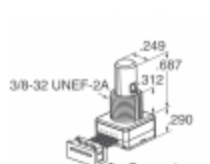
Verwandte Produkte

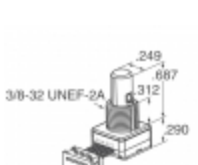
 <p>62S11-N4-025C Hersteller: Grayhill, Inc. Beschreibung: ROTARY ENCODER OPTICAL 32PPR Auf Lager: 1970 pcs</p> <p>RFQ</p>	 <p>62S11-N4-120S Hersteller: Grayhill, Inc. Beschreibung: ROTARY ENCODER OPTICAL 32PPR Auf Lager: 2038 pcs</p> <p>RFQ</p>
 <p>62S11-N3-PH Hersteller: Grayhill, Inc. Beschreibung: ROTARY ENCODER OPTICAL 32PPR Auf Lager: 1856 pcs</p> <p>RFQ</p>	 <p>62S11-N2-P Hersteller: Grayhill, Inc. Beschreibung: ROTARY ENCODER OPTICAL 32PPR Auf Lager: 2376 pcs</p> <p>RFQ</p>
 <p>62S11-N4-PH Hersteller: Grayhill, Inc. Beschreibung: ROTARY ENCODER OPTICAL 32PPR Auf Lager: 1970 pcs</p> <p>RFQ</p>	 <p>62S11-N4-020C Hersteller: Grayhill, Inc. Beschreibung: ROTARY ENCODER OPTICAL 32PPR Auf Lager: 2083 pcs</p> <p>RFQ</p>
 <p>62S11-N2-040C Hersteller: Grayhill, Inc. Beschreibung: ROTARY ENCODER OPTICAL 32PPR Auf Lager: 2333 pcs</p> <p>RFQ</p>	 <p>62S11-N2-PH Hersteller: Grayhill, Inc. Beschreibung: ROTARY ENCODER OPTICAL 32PPR Auf Lager: 1760 pcs</p> <p>RFQ</p>
 <p>62S11-N4-060SH Hersteller: Grayhill, Inc. Beschreibung: ROTARY ENCODER OPTICAL 32PPR Auf Lager: 2262 pcs</p> <p>RFQ</p>	 <p>62S11-N5-025C Hersteller: Grayhill, Inc. Beschreibung: ROTARY ENCODER OPTICAL 32PPR Auf Lager: 2408 pcs</p> <p>RFQ</p>
 <p>62S11-N5-025CH Hersteller: Grayhill, Inc. Beschreibung: ROTARY ENCODER OPTICAL 32PPR Auf Lager: 2083 pcs</p> <p>RFQ</p>	 <p>62S11-N4-P Hersteller: Grayhill, Inc. Beschreibung: ROTARY ENCODER OPTICAL 32PPR Auf Lager: 1912 pcs</p> <p>RFQ</p>

Copyright © 2020 Zuverlässiger Distributor von elektronischen Komponenten

Email: Info@infinity-electronic.com

Adresse: 17F, Gaylord Geschäftshaus, 114-118 Lockhart Road, Wan Chai, Hongkong

