





Grayhill, Inc.

62S11-N4-PH

Teilenummer:	62S11-N4-PH
Hersteller / Marke:	Grayhill, Inc.
Produktbeschreibung	ROTARY ENCODER OPTICAL 32PPR
Datenblätter:	 62S11-N4-PH.pdf
RoHS Status	 Bleifrei / RoHS-konform
Zustand des Lagers	1970 pcs stock
Lieferrn von	Hongkong
Versandweg	DHL/Fedex/TNT/UPS/EMS



[ANGEBOTSANFRAGE](#)

Bild kann Darstellung sein. Siehe Spezifikationen für Produktdetails.





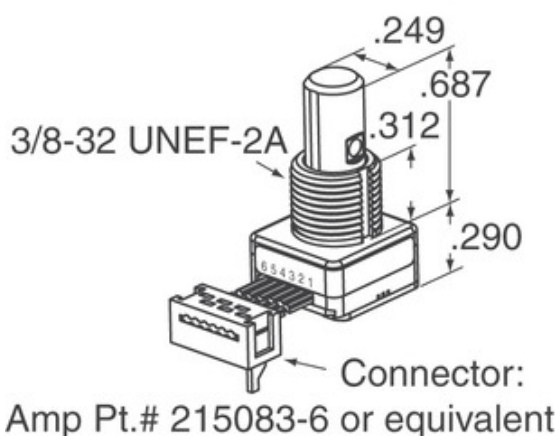

Spezifikationen von 62S11-N4-PH

TEILENUMMER	62S11-N4-PH
HERSTELLER	Grayhill, Inc.
BESCHREIBUNG	ROTARY ENCODER OPTICAL 32PPR
BLEIFREIER STATUS / ROHS STATUS	Bleifrei / RoHS-konform
VERFÜGBARE MENGE	1970 pcs
DATENBLATT	 62S11-N4-PH.pdf
SPANNUNGSVERSORGUNG	5V
ABSCHLUSSART	PC Pin
SERIE	62S
ROTATIONSLEBENSDAUER (ZYKLEN MIN)	1M
IMPULSE PRO UMDREHUNG	32
AUSGABETYP	Quadrature (Incremental)
ANDERE NAMEN	62S11N4PH
ORIENTIERUNG	Vertical
BEFESTIGUNGSART	PCB, Through Hole
FEUCHTIGKEITSEMPFINDLICHKEITSNIVEAU (MSL)	1 (Unlimited)
BLEIFREIER STATUS / ROHS-STATUS	Lead free / RoHS Compliant
ENCODERTYP	Optical
RASTE	No
INTEGRIERTER SCHALTER	Yes
BETÄTIGERTYP	1/4" Dia Flatted End

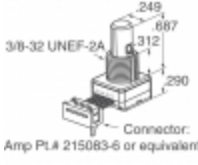
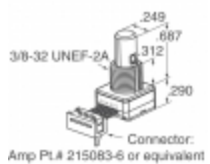
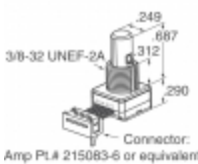
Verwandte Tags

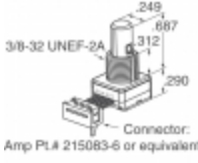
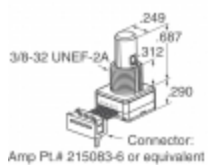
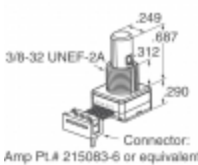
Grayhill, Inc. 62S11-N4-PH	62S11-N4-PH-Vertriebspartner	62S11-N4-PH Lieferant
62S11-N4-PH Preis	62S11-N4-PH Bilder	62S11-N4-PH-Bild
62S11-N4-PH PDF-Datenblatt	62S11-N4-PH Datenblatt herunterladen	62S11-N4-PH Datenblatt
62S11-N4-PH-Bestand	62S11-N4-PH kaufen	Grayhill, Inc. kaufen 62S11-N4-PH
Grayhill, Inc. 62S11-N4-PH	Grayhill, Inc. Lieferant	Grayhill, Inc.-Vertriebspartner
Grayhill, Inc. 62S11-N4-PH	Grayhill Inc. 62S11-N4-PH	

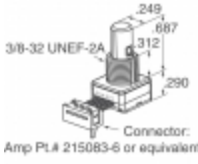
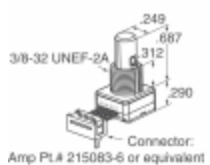
Verwandte Produkte

 <p>62S11-N4-025C Hersteller: Grayhill, Inc. Beschreibung: ROTARY ENCODER OPTICAL 32PPR Auf Lager: 1970 pcs</p> <p>RFQ</p>	 <p>62S11-N4-120S Hersteller: Grayhill, Inc. Beschreibung: ROTARY ENCODER OPTICAL 32PPR Auf Lager: 2038 pcs</p> <p>RFQ</p>
 <p>62S11-N4-025CH Hersteller: Grayhill, Inc. Beschreibung: ROTARY ENCODER OPTICAL 32PPR Auf Lager: 1946 pcs</p> <p>RFQ</p>	 <p>62S11-N5-060SH Hersteller: Grayhill, Inc. Beschreibung: ROTARY ENCODER OPTICAL 32PPR Auf Lager: 2263 pcs</p> <p>RFQ</p>
 <p>62S11-N4-020C Hersteller: Grayhill, Inc. Beschreibung: ROTARY ENCODER OPTICAL 32PPR Auf Lager: 2083 pcs</p> <p>RFQ</p>	 <p>62S11-N5-060C Hersteller: Grayhill, Inc. Beschreibung: ROTARY ENCODER OPTICAL 32PPR Auf Lager: 2164 pcs</p> <p>RFQ</p>
 <p>62S11-N4-P Hersteller: Grayhill, Inc. Beschreibung: ROTARY ENCODER OPTICAL 32PPR Auf Lager: 1912 pcs</p> <p>RFQ</p>	 <p>62S11-N5-050C Hersteller: Grayhill, Inc. Beschreibung: ROTARY ENCODER OPTICAL 32PPR Auf Lager: 1936 pcs</p> <p>RFQ</p>
 <p>62S11-N5-025CH Hersteller: Grayhill, Inc. Beschreibung: ROTARY ENCODER OPTICAL 32PPR Auf Lager: 2083 pcs</p> <p>RFQ</p>	 <p>62S11-N5-040C Hersteller: Grayhill, Inc. Beschreibung: ROTARY ENCODER OPTICAL 32PPR Auf Lager: 2106 pcs</p> <p>RFQ</p>
 <p>62S11-N4-060SH Hersteller: Grayhill, Inc. Beschreibung: ROTARY ENCODER OPTICAL 32PPR Auf Lager: 2262 pcs</p> <p>RFQ</p>	 <p>62S11-N5-025C Hersteller: Grayhill, Inc. Beschreibung: ROTARY ENCODER OPTICAL 32PPR Auf Lager: 2408 pcs</p> <p>RFQ</p>

Copyright © 2020 Zuverlässiger Distributor von elektronischen Komponenten

Email: Info@infinity-electronic.com

Adresse: 17F, Gaylord Geschäftshaus, 114-118 Lockhart Road, Wan Chai, Hongkong

